

**RAINWATER SOLUTIONS,  
WE'LL BRING THE  
How To.**

**STRATCO**



**RAINWATER GOODS**

ROOFING | WALLING | GUTTERING | FASCIA | ACCESSORIES

# ROOFING & WALLING

**RANGE AND AVAILABILITY:** Stratco has a comprehensive range of roofing and rainwater products, and all of the accessories needed to complete your project. A wide range of custom designed products can also be produced to your requirements. Not all products and sizes are available nationally. National product availability is shown by the shaded areas on the map of Australia next to each product. Check with Stratco to confirm availability before ordering any materials.

## CGI CORRUGATED 16

Stratco Corrugated Iron (CGI) has a timeless appeal with soft flowing lines that possess both looks and strength. CGI is a versatile building material that will complement both contemporary and colonial styled homes, and can be applied to a wide variety of applications.

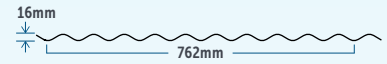
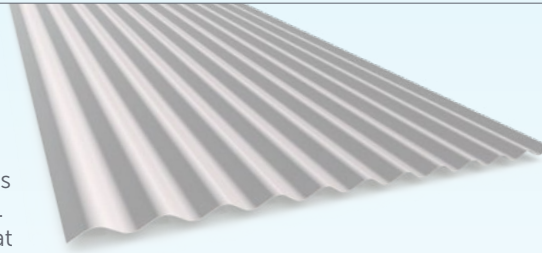

MINIMUM PITCH 5°  
TOLERANCE L±5mm W±2mm

Span Type	Roofing (BMT)		Walling (BMT)		
	0.42mm	0.48mm	0.35mm	0.42mm	0.48mm
Single Span	800	900	1300	1650	1900
End Span	950	1300	1750	2100	2250
Internal Span	1200	1800	2300	2700	2800
Un-stiffened Overhang	200	250	150	200	250
Stiffened Overhang	300	350	250	300	350

## MAXIMUS® 22

Stratco Maximus 22 Corrugated roofing - where a timeless classic meets and compliments modern, contemporary and traditional design. With the stronger Maximus profile, Stratco offers not only market leading technology and product quality, but now has an extended corrugated roofing product range.

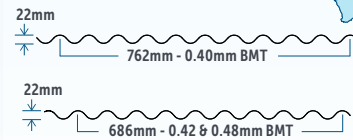
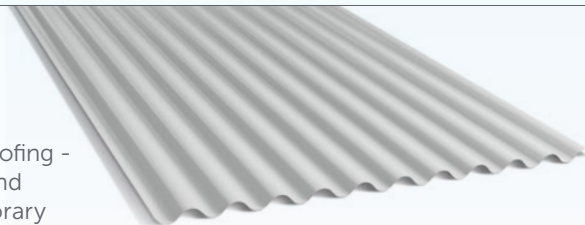

MINIMUM PITCH 3°  
TOLERANCE L±5mm W±2mm

Span Type	Roofing (BMT)			Walling (BMT)
	0.40mm	0.42mm	0.48mm	0.42mm
Single Span	800	900	1100	1900
End Span	1200	1350	1650	2500
Internal Span	1400	1500	2000	2700
Un-stiffened Overhang	250	250	250	300
Stiffened Overhang	400	400	450	300

\*Note: 762mm - 0.42mm BMT Galv. available - SA only.

## MAXIMUS® 33

Stratco Maximus 33 Corrugated roofing provides more choice and additional features. This deeper, rounder, well-formed Maximus corrugated profile now provides the ultimate solution and adaptability to all steel walling and roofing applications.

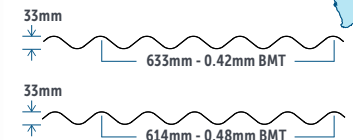

MINIMUM PITCH 2°  
TOLERANCE L±5mm W±2mm

Span Type	Roofing (BMT)	Walling (BMT)
	0.48mm	0.42mm
Single Span	1300	2400
End Span	1600	2700
Internal Span	2500	2700
Un-stiffened Overhang	250	400
Stiffened Overhang	450	400

\*Note: 760mm - 0.40mm BMT available - SA only.

## SUPERDEK®

The Superdek profile is particularly suitable for roofing, wall cladding and fencing projects. Its high-tensile strength and its trapezoidal shape have made it a popular choice for a wide variety of applications. For low cost, pierce fix, industrial roofing, Superdek is the material to choose.

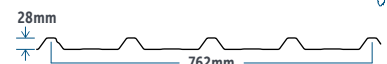
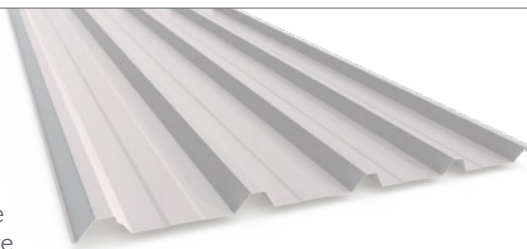

MINIMUM PITCH 2°  
TOLERANCE L±5mm W±2mm

Span Type	Roofing (BMT)		Walling (BMT)		
	0.42mm	0.48mm	0.35mm	0.42mm	0.48mm
Single Span	1150	1700	1700	2350	2800
End Span	1350	1900	2200	2850	3200
Internal Span	1900	2600	2500	3000	3300
Un-stiffened Overhang	200	250	150	200	250
Stiffened Overhang	300	350	300	300	350

**TECHNICAL INFORMATION:** Roofing spans in this booklet are maximum recommended values under normal conditions for use in non-cyclonic areas with a wind classification N2 (33m/sec), and tested to the limit state design format. For further information on spans contact Stratco. Roofing will support light maintenance traffic. Gutter capacities are calculated per the Australian Standards, the actual capacity is larger. Refer to the 'Selection, Use and Maintenance of Stratco Products' and individual product brochures for more information. Stratco steel roofing products are non-combustible.

### PRODEK®

Prodek has been designed with versatility in mind. It possesses a modern, attractive profile that has the strength and flexibility to be used for a wide variety of applications. It is ideal for use on anything from long length industrial roofing to verandah, patio and carport installations.

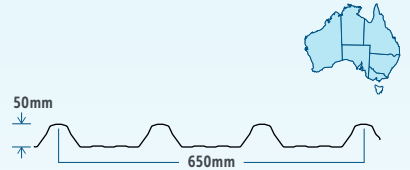
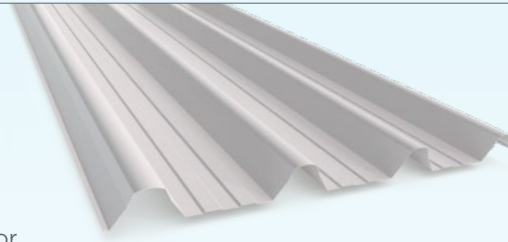

Span Type	Roofing (BMT)		Walling (BMT)		
	0.42mm	0.48mm	0.35mm	0.42mm	0.48mm
Single Span	2600	3100	2400	3000	3600
End Span	2800	3400	2700	3500	4000
Internal Span	3200	3800	3000	3800	4200
Un-stiffened Overhang	200	250	150	200	250
Stiffened Overhang	600	650	400	600	650

MINIMUM PITCH 1°  
TOLERANCE L±5mm W±2mm

### HILAND TRAY

Stratco Hiland Tray™ is a modern architectural roofing and walling profile providing a clean finish with smooth, uncluttered lines.

Available in Nailstrip and Snaplock versions.

Other coverage options are available on request.

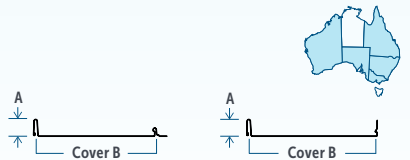

NAILSTRIP COVERAGE			SNAPLOCK COVERAGE		
A	Cover	BMT	A	Cover	BMT
25	195	.55	25	225	0.55
25	295	.55	25	325	0.55
25	350	.60	38	185	0.55
38	165	.55	38	285	0.55
38	265	.55	38	340	0.60
38	320	.60			

MINIMUM PITCH 2°  
TOLERANCE L±7mm W±4mm

### HILAND INTERLOCK CLADDING

Stratco Hiland Interlock Cladding is a modern architectural wall cladding system ideal for domestic and commercial applications. It can be installed either vertically or horizontally to achieve the perfect look for any project. Interlock Cladding has a panel height of 25mm high.

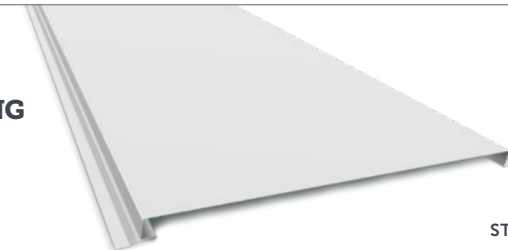

RETENTION CLIP FOR CONCEALED FIXING

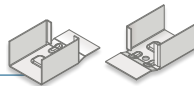

NOT SUITABLE FOR ROOFING USE  
TOLERANCE L±7mm W±4mm

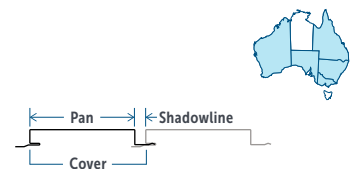

STANDARD COVERAGE			OTHER COVERAGE		
Cover	Pan	Shadowline	Cover	Pan	Shadowline
190	175	15	290	275	15
195	185	10	295	285	10
200	195	5	300	295	5
			490	475	15
			495	485	10
			500	495	5

### SMARTSPAN®

The contemporary form of Smartspan features a square corrugated profile. Its nine-rib design provides maximum strength, making it ideal where a very strong but simple appearance is required. Smartspan is a remarkably versatile product with both domestic and industrial applications.

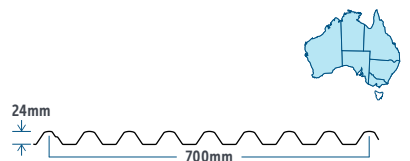

Span Type	Roofing (BMT)		Walling (BMT)	
	0.42mm	0.48mm	0.42mm	0.48mm
Single Span	1350	2000	2550	2600
End Span	1800	2300	3200	3300
Internal Span	2400	3000	3500	3600
Un-stiffened Overhang	200	250	200	250
Stiffened Overhang	500	600	500	600

MINIMUM PITCH 2°  
TOLERANCE L±5mm W±2mm

# ROOFING & WALLING

**RANGE AND AVAILABILITY:** Stratco has a comprehensive range of roofing and rainwater products, and all of the accessories needed to complete your project. A wide range of custom designed products can also be produced to your requirements. Not all products and sizes are available nationally. National product availability is shown by the shaded areas on the map of Australia next to each product. Check with Stratco to confirm availability before ordering any materials.

## TOPDEK® 700

Topdek 700 is a roof decking that is attached with a concealed clip. This ingenious system provides a clean and strong finish, without visible fixings. It allows for thermal expansion and contraction, making it ideal for long length roofing in both domestic and commercial uses.

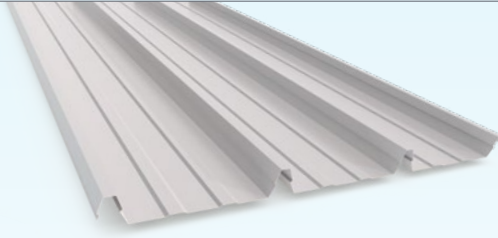

Span Type	Roofing (BMT)		Walling (BMT)	
	0.42mm	0.48mm	0.42mm	0.48mm
Single Span	2000	2200	2850	3000
End Span	2200	2950	3000	3250
Internal Span	2300	3100	3200	3600
Un-stiffened Overhang	200	200	300	300
Stiffened Overhang	600	600	400	400

MINIMUM PITCH 1°  
TOLERANCE L±5mm W±2mm

## CGI MINI

CGI Mini has a charismatic profile that can be used to great effect as a decorative finish. It is widely used by the interior design and shop fitting industry. Its high-tensile steel profile is suitable for internal and external applications, on both straight and curved surfaces.

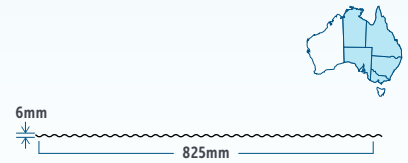
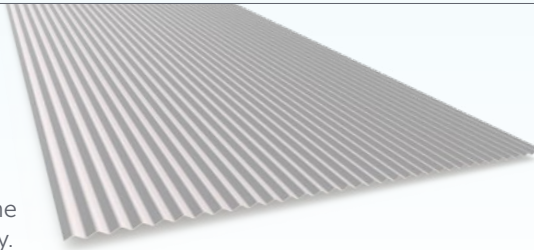

Span Type	Walling (BMT)		
	0.35mm	0.42mm	0.48mm
Single Span	800	900	1000
End Span	900	1000	1100
Internal Span	1000	1200	1300

NOT SUITABLE FOR ROOFING USE  
TOLERANCE L±15mm W±4mm

## MAXIRIB™

The thin, attractive profile of Stratco Maxirib makes it the perfect wall cladding solution. It is designed for versatility and presents a low profile appearance. Maxirib is the ideal choice for use on ceilings, walling, screens, garage doors, fascias and barge boards.

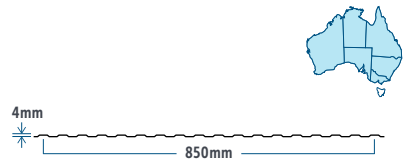

Span Type	Walling 0.42mm BMT		
	N1 (W28)	N2 (W33)	N3 (W41)
Single Span	1200	1100	900
End Span	1350	1200	1000
Internal Span	1350	1200	1000
Overhang	150	150	150

NOT SUITABLE FOR ROOFING USE  
TOLERANCE L±5mm W±2mm

## STRATCLAD™

Stratclad is a versatile wall cladding material suitable for a variety of applications. The wide coverage of up to 1110mm means less sheets are required to cover the chosen area. Stratclad can be cut to custom width to suit your special requirements. Stratclad 870 features S-Lock, a specialised notch on one sheet edge for the proceeding edge to slot into.

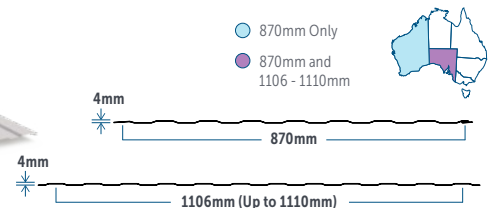
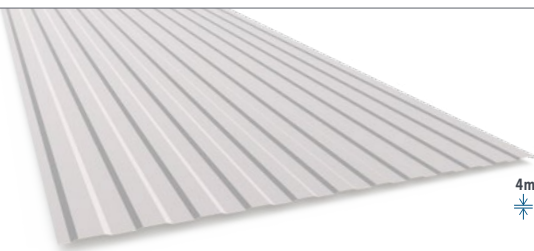

Span Type	0.35mm BMT			0.40 & 0.42mm BMT			0.55mm BMT		
	N1 (W28)	N2 (W33)	N3 (W41)	N1 (W28)	N2 (W33)	N3 (W41)	N1 (W28)	N2 (W33)	N3 (W41)
Single Span	650	550	350	800	700	500	1000	900	700
End Span	750	650	500	900	800	650	1150	1000	800
Internal Span	750	650	500	900	800	650	1150	1000	800
Overhang	100	100	100	150	150	150	150	150	150

NOT SUITABLE FOR ROOFING USE  
TOLERANCE L±5mm W±2mm

**TECHNICAL INFORMATION:** Roofing spans in this booklet are maximum recommended values under normal conditions for use in non-cyclonic areas with a wind classification N2 (33m/sec), and tested to the limit state design format. For further information on spans contact Stratco. Roofing will support light maintenance traffic. Gutter capacities are calculated per the Australian Standards, the actual capacity is larger. Refer to the 'Selection, Use and Maintenance of Stratco Products' and individual product brochures for more information. Stratco steel roofing products are non-combustible.

**COOLDEK®**

The innovative Cooldek insulated panel provides a roof, insulation and ceiling like finish all in one product. With superior spanning capabilities, two roof profiles and their insulation thicknesses to choose from, it is an ideal solution for domestic patio roof applications.

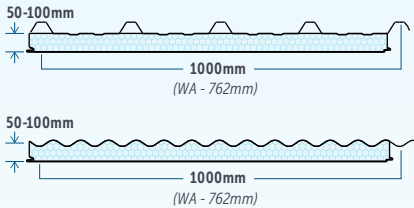
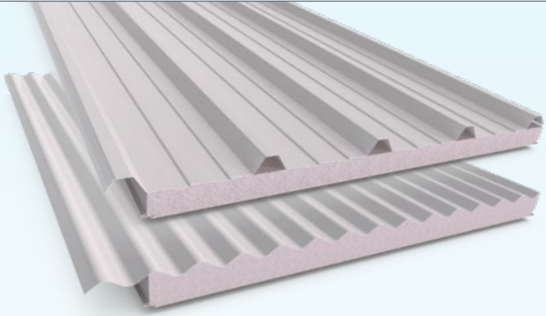

COOLDEK CLASSIC - MINIMUM PITCH 2°  
COOLDEK CGI - MINIMUM PITCH 3°

**BULLNOSING AND CURVING**

Stratco can curve your CGI curving sheet into a variety of forms to produce bullnose roofing or barrel vaulting (a complete half circle), in either concave or convex arrangements. Finish your curving project with accessories manufactured by Stratco such as curved flashings to match your sheeting radius and curved hip bars for bracing the hip joint.

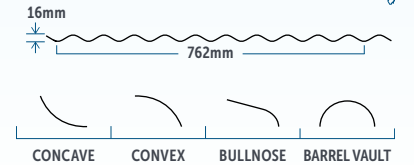
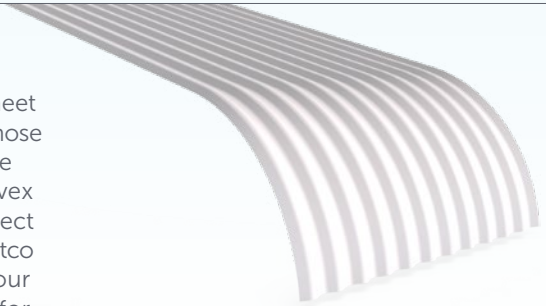

MINIMUM RECOMMENDED CURVING RADIUS IS 450mm.  
MINIMUM PITCH 5°  
TOLERANCE L±5mm W±2mm

Application	0.60mm BMT	
	Internal Spans (mm)	End Spans (mm)
Roofing	1800	1600
Walling	3000	2900

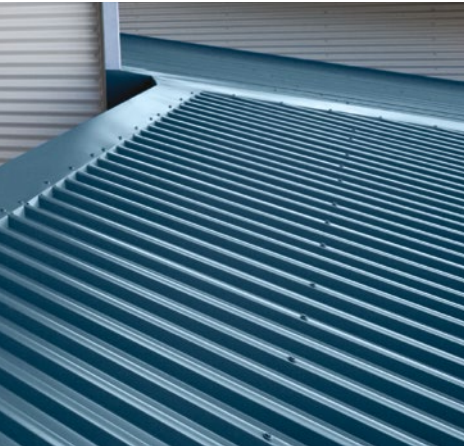

# ROOFING ACCESSORIES

**RANGE AND AVAILABILITY:** Stratco has a comprehensive range of roofing and rainwater products, and all of the accessories needed to complete your project. A wide range of custom designed products can also be produced to your requirements. Not all products and sizes are available nationally. National product availability is shown by the shaded areas on the map of Australia next to each product. Check with Stratco to confirm availability before ordering any materials.

## POLYCARBONATE SHEETING

Polycarbonate is a very durable, high impact translucent sheeting with 99.9% UV protection. It comes in a variety of profiles and colours. A metallic option can be ordered that is great at reflecting heat. An infrared coated sheet is also available for the ultimate in heat reflection, UV protection and durability.

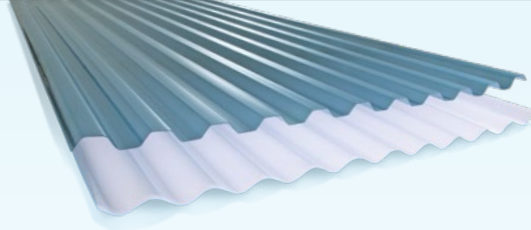

- Profiles Available
- Corrugated —
  - Greca —
  - Superdek —

## FIBREGLASS SHEETING

Fibreglass is an affordable translucent sheeting that is versatile, light and easy to use. It is ideal for creating skylights on roofing, verandahs and sheds. It comes in a wide range of profiles and colours, making it easy to find a style of sheet to complement your project.

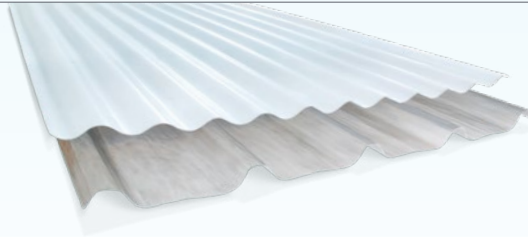

- Profiles Available
- Corrugated —
  - Smartspan —
  - Superdek —
  - Prodek —
  - Topdek —
  - Spacedek —

## INSULATION

Stratco can supply all your insulation materials and accessories. Foil insulation and foil faced building blankets are available in a range of weights that provide varying degrees of insulation. Insulation batts come in various thicknesses, grades and pack sizes. Complete the job with foil tacks, foil insulation tape and either square mesh or safety roof mesh.



## FASTENERS

Finish the job with the right fasteners supplied by Stratco. Choose from screws to fix timber or steel, with or without seals, for crest or pan fixing. Stratco can supply wafer head screws, batten fixing screws, ripple self-drilling and tapping screws, rivets, bolts, coach screws, masonry anchors and polycarbonate fasteners, all in varying sizes for each job.



## FLUE CAPS

Flue caps prevent birds, water and smoky smells from entering the building through the flue. Smoky smells are prevented by keeping rain from coming down the flue and mixing with the creosote inside the chimney. Flue caps are available in 150, 200, 225 and 300mm diameters. Galvanised, Zinc/Al and a full range of roofing colours are available.



FLUE CAPS



CAP LENGTHS AND CASINGS

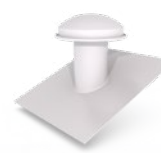

CAP LENGTHS WITH CAP AND BASE



FLUME ADAPTOR (SPUN)



STANDARD SIZES (mm)

Type	Flue Caps				Casing Only				Cap Lengths with Cap				Flume Adaptor (Spun)				
Diameter	150	200	225	300	150	150	150	150	150*	150	150*	150	150	150	200	225	300
Length	n/a	n/a	n/a	n/a	600	900	1200	1800	450*	600	600*	900	1200	n/a	n/a	n/a	n/a

\*With base, nominal pitch.

**TECHNICAL INFORMATION:** Roofing spans in this booklet are maximum recommended values under normal conditions for use in non-cyclonic areas with a wind classification N2 (33m/sec), and tested to the limit state design format. For further information on spans contact Stratco. Roofing will support light maintenance traffic. Gutter capacities are calculated per the Australian Standards, the actual capacity is larger. Refer to the 'Selection, Use and Maintenance of Stratco Products' and individual product brochures for more information. Stratco steel roofing products are non-combustible.

### RIDGE CAPPING

Two styles of ridge capping are offered. Roll Type Ridge Cap is a traditional style of ridge cap that is commonly found on corrugated steel roofs. In some States, a stiffening rib is formed into the skirt of the ridge to add strength and assist with placing the screws. Alternatively, a simple 3 Bend Ridge Cap can be pressed to your exact requirements.

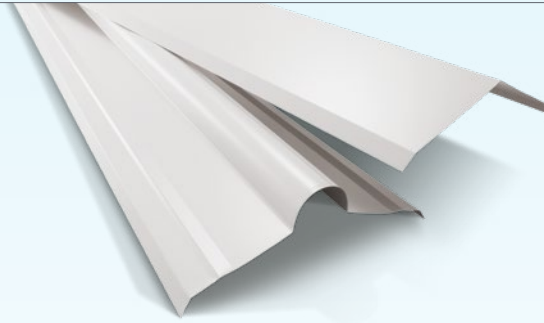

A 32mm SCRIBING BREAK IS AVAILABLE WHEN ORDERING.

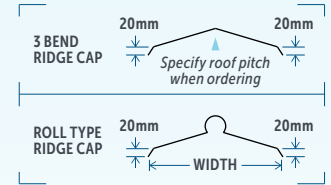

### VALLEY GUTTER

Stratco manufacture a standard valley gutter in galvanised, Zinc/Al or a full range of roofing colours, to a length that will suit your requirements. Stratco Valley Gutter is available in 355mm or 405mm girth in .40mm and .55mm thicknesses. A tile valley gutter is available for the Queensland market only. It has a girth of 450mm, in .40mm and .55mm thicknesses.



STOCK LENGTHS 1800mm.

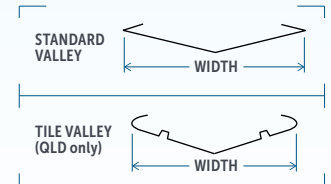

### BARGE CAPPING

Stratco offers several different styles of barge capping to complete the edge of your roofing. Square Barges provide a neat finish and can be ordered in a variety of sizes to fit any style of roof sheeting. Roll barges have a curved edge that creates a traditional form that blends beautifully with corrugated sheeting. Check with your State to see what styles are available.



EXAMPLES ONLY, CHECK AVAILABILITY IN YOUR STATE.

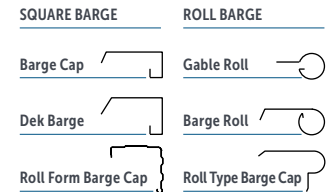

### VENTILATORS

Aluminium domestic turbine ventilators can be fitted to any roof, shed or garage to provide natural ventilation through the power of wind. They come in a full range of roofing colours. Domestic ventilators are 300mm in diameter. Industrial ventilators are available in a curved or straight blade style, and a range of sizes.

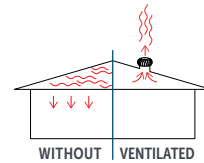

Number of Domestic Ventilators Required

House Size	Number of Units
90 - 110m <sup>2</sup>	1
160 - 180m <sup>2</sup>	2
220 - 270m <sup>2</sup>	3

### SUPAVENT

SupaVent is a wind driven turbine ventilator designed to exhaust heat and moisture from the roof space of a home, without the use or electrical energy. Constructed from light-weight, high quality polymer, it comes with a 15 year warranty for long lasting peace of mind and comfort in your home. Available in a range of 17 colours to suit most metal and tile roofs.

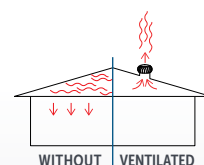

Number of Domestic Ventilators Required

House Size	Number of Units
90m <sup>2</sup>	1-2

# GUTTER RANGE

**RANGE AND AVAILABILITY:** Stratco has a comprehensive range of roofing and rainwater products, and all of the accessories needed to complete your project. A wide range of custom designed products can also be produced to your requirements. Not all products and sizes are available nationally. National product availability is shown by the shaded areas on the map of Australia next to each product. Check with Stratco to confirm availability before ordering any materials.

## EDGE GUTTER

Modern, architecturally designed homes require a gutter with simple, clean and refined lines. Stratco Edge Gutter features the latest cutting edge styling in gutter design. Available in a huge range of colours and with a large water carrying capacity, Stratco Edge Gutter is both stylish and practical.

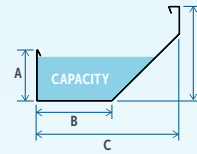
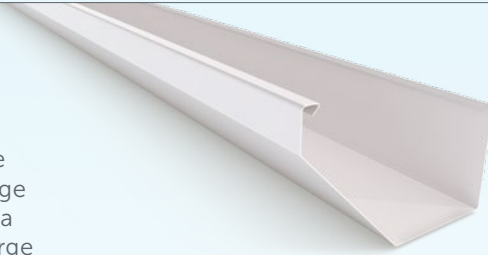

DIMENSIONS	Edge 160	Edge 200	Edge 200*
A	74	110	75
B	81	100	110
C	159	200	210
D	103	140	140

CAPACITY (mm <sup>3</sup> )	Edge 160	Edge 200	Edge 200*
Standard	7125	14,858	9151

\*Available - WA only.

## QUAD GUTTER

Quad Gutter is so adaptable because of its classic form. It can blend perfectly with older style colonial and cottage homes and is also used extensively in new home construction. It is available in a wide choice of sizes and can be optioned with slots to prevent water overflow.

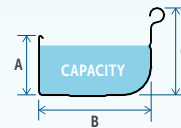
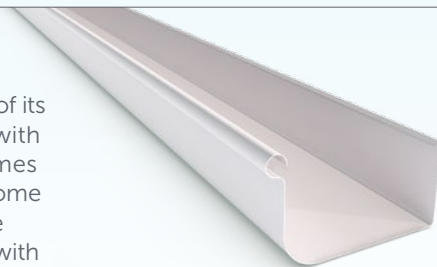

DIMENSIONS	115 <sup>^</sup>	115 Low Front*	125*	125**	125†	150†	175†
A	61	49	64	60	61	79	103
B	115	113	125	127	127	138	175
C	90	72	70	84	90	76	95

CAPACITY (mm <sup>3</sup> )							
Standard	5621	4307	6488	6697	6488	8685	12,213
Slotted	5057	-	-	-	5592	-	-

\*Available - NSW.  
 \*\*Available - SA, NT.  
 †Available - QLD  
<sup>^</sup>Available - NSW, VIC, SA, WA, NT.

## OG GUTTER

Stratco OG Gutter is a traditional gutter with a charismatic profile. 'OG' stands for 'Old Gothic'. Its style makes it the ideal choice for use on both traditional and modern homes.

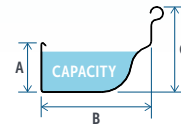
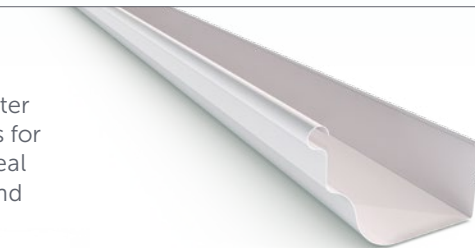

DIMENSIONS	TYPE	A	B	C
	125 OG	56	125	97
	125 Ribbed*	62	124	90

CAPACITY (mm <sup>3</sup> )	TYPE	Standard	Slotted
	125 OG	4432	3374
	125 Ribbed*	5500	4654

\*Available - SA only.

## SMOOTHLINE® GUTTER

When attached to fascia, Smoothline Gutter has the same appearance as Half Round Gutter. However unlike Half Round Gutter, Smoothline has a flat back. Smoothline Gutter is easy to fix, easy to paint and maintain, and is economical because it uses internal brackets.

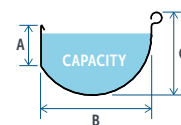
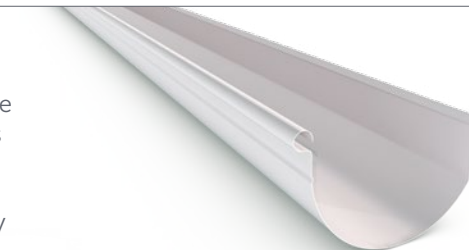

DIMENSIONS	TYPE	A	B	C
	Smoothline	51	138	104

CAPACITY (mm <sup>3</sup> )	TYPE	Standard	Slotted
	Smoothline	8748	6961

## HALF ROUND GUTTER

The appealing shape of Half Round Gutter is largely self cleaning and has a good water carrying ability due to its wide 150mm diameter. Half Round is ideal for modern homes and is also popular on industrial and office buildings because of its clean, smooth, practical shape.

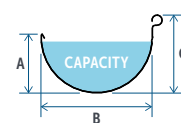
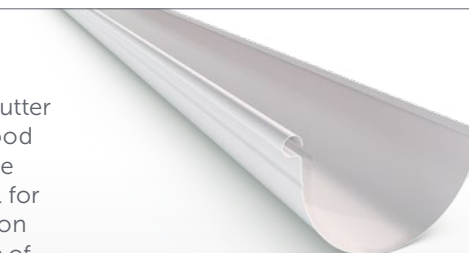

DIMENSIONS	TYPE	A	B	C
	Half Round	78	148	104

CAPACITY (mm <sup>3</sup> )	TYPE	Standard	Slotted
	Half Round	7703	7126



**TECHNICAL INFORMATION:** Calculation of effective cross sectional area 'Capacity' for each nominal size of eaves gutter is based on requirements of section 3.8 AS/NZS 2179.1:1994. Gutter capacities are calculated per the Australian Standards, the actual capacity is larger. Refer to the 'Selection, Use and Maintenance of Stratco Products' and individual product brochures for more information.

### HK GUTTER

HK Gutter or 'Household K' presents a neat, smooth, modern appearance. Lengths are cut to your requirements, in a choice of Zinc/Al, galvanised, or pre-coloured steel. HK Gutter is available with slots to minimise overflow during heavy downpours.

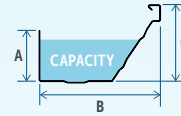
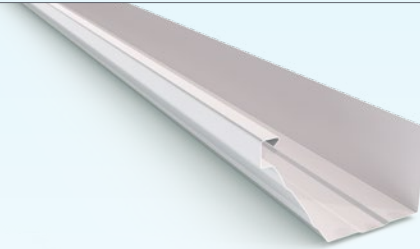

DIMENSIONS	TYPE	A	B	C
	HK	65	133	84

CAPACITY (mm <sup>2</sup> )	TYPE	Standard	Slotted
	HK	5394	3717

### QUARTER ROUND GUTTER

An attractive gutter profile that will complement any architectural style. The partially flat base enables it to be used on any rebate fascia. The profile efficiently channels even the smallest amount of water to the back of the gutter for disposal, thereby reducing silt and debris build up.

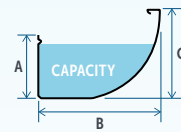
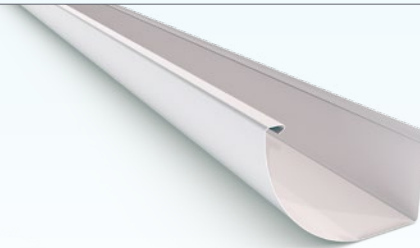

DIMENSIONS	TYPE	A	B	C
	Qtr Round	71	134	100

CAPACITY (mm <sup>2</sup> )	TYPE	Standard	Slotted
	Qtr Round	6292	5054

### VFC GUTTER

VFC Gutter has a compact, modern appearance that suits contemporary homes. It has a square front that is designed to hide the end of the roof sheets, providing a neat face to your roofing. It is available with slots to allow excess water to overflow.

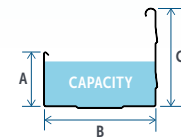
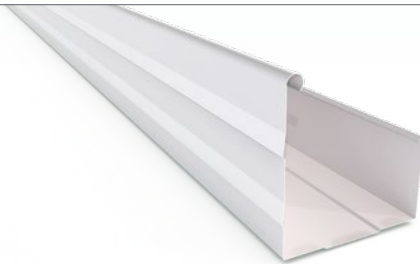

DIMENSIONS	TYPE	A	B	C
	VFC	67	119	130

CAPACITY (mm <sup>2</sup> )	TYPE	Standard	Slotted
	VFC	6775	5475

### VF GUTTER

VF Gutter has been specifically designed for verandah and carport applications. It has an attractive square front and a unique fold at the back of the gutter that enables it to be easily secured to the roof sheeting. It is often used in industrial roofing applications as well.

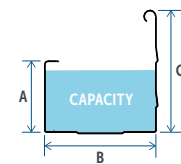
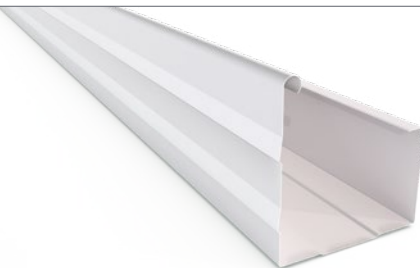

DIMENSIONS	TYPE	A	B	C
	VF	76	119	130

CAPACITY (mm <sup>2</sup> )	TYPE	Standard	Slotted
	VF	7839	5475

### VT GUTTER

Designed to hide the roof sheets or roof tiles from view, VT Gutter has a smooth face with simple lines that will complement any style of home from colonial to contemporary. It is available with slots to allow excess water to overflow during heavy downpours.

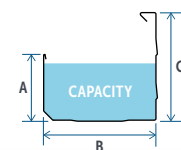
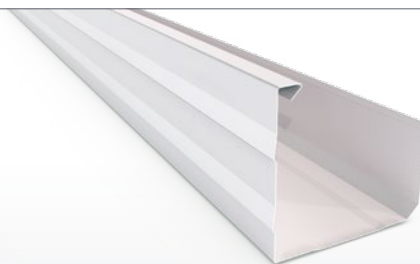

DIMENSIONS	TYPE	A	B	C
	VT	73	125	120

CAPACITY (mm <sup>2</sup> )	TYPE	Standard	Slotted
	VT	-	6338

# GUTTER RANGE & ACCESSORIES

**RANGE AND AVAILABILITY:** Stratco has a comprehensive range of roofing and rainwater products, and all of the accessories needed to complete your project. A wide range of custom designed products can also be produced to your requirements. Not all products and sizes are available nationally. National product availability is shown by the shaded areas on the map of Australia next to each product. Check with Stratco to confirm availability before ordering any materials.

## VFM GUTTER

VFM Gutter has a 138mm square front that is ideal for covering the end of roof sheets or roof tiles. It has a clean profile and a suspension rib in the back face for strength. VFM Gutter has excellent water carrying abilities and has slots to allow for water overflow.

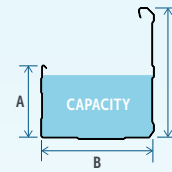
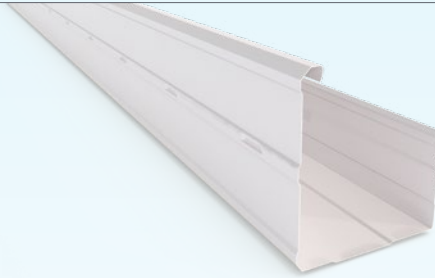

DIMENSIONS	TYPE	A	B	C
	VFM	77	120	138

CAPACITY (mm <sup>2</sup> )	TYPE	Standard	Slotted
	VFM	-	6711

## HI-SQUARE GUTTER

Hi-Square Gutter has a 130mm high front that will provide a visual cover to the end of roof sheets and roof tiles. Its square front design delivers a neat finish to any home or building. It is manufactured with a slotted face to reduce water overflow into the building.

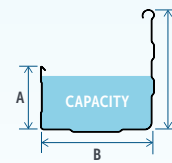
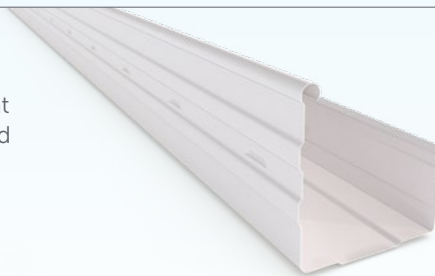

DIMENSIONS	TYPE	A	B	C
	Hi-Square	67	118	130

CAPACITY (mm <sup>2</sup> )	TYPE	Standard	Slotted
	Hi-Square	-	5974

## C-SQUARE GUTTER

Designed specifically for verandah and carport applications, C or 'Commercial' Square Gutter is commonly used in commercial applications where a modern, attractive gutter is required. A unique fold at the back of the gutter enables it to be easily secured to roof sheeting.

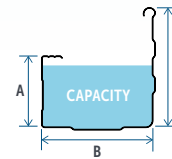
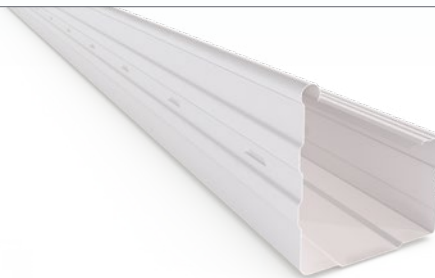

DIMENSIONS	TYPE	A	B	C
	C-Square	76	118	130

CAPACITY (mm <sup>2</sup> )	TYPE	Standard	Slotted
	C-Square	-	5974

## OG BIG ONE™

OG Big One has a clean, stylish, 'Old Gothic' face and is designed for commercial buildings. It is capable of carrying large amounts of water. The width can be varied to suit your needs and is available in long lengths of up to 7.5m reducing installation costs. Slots are available.

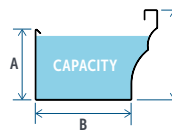
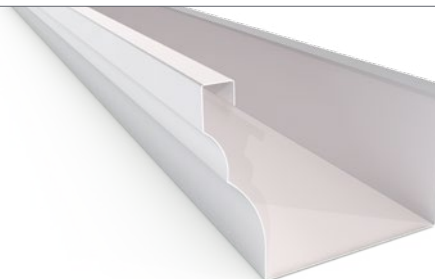

DIMENSIONS	TYPE	A	B	C
	450	110	150	140
	600	140	210	200

CAPACITY (mm <sup>2</sup> )	TYPE	Standard	Slotted
	450	-	9881
	600	-	26,345

## S GUTTER

Stratco S Gutter has a colonial homestead style that is reflected in the gentle curves of its profile. It is ideal for period restorations and modern homes with a traditional feel. It features a 90mm high front to hide the roofline and is available with slots to allow water to overflow.

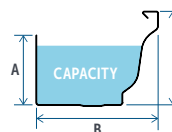
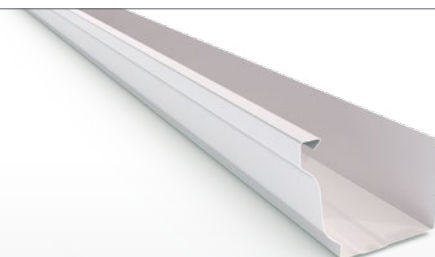

DIMENSIONS	TYPE	A	B	C
	S	62	117	90

CAPACITY (mm <sup>2</sup> )	TYPE	Standard	Slotted
	S	5315	4609

**TECHNICAL INFORMATION:** Calculation of effective cross sectional area 'Capacity' for each nominal size of eaves gutter is based on requirements of section 3.8 AS/NZS 2179.1:1994. Gutter capacities are calculated per the Australian Standards, the actual capacity is larger. Refer to the 'Selection, Use and Maintenance of Stratco Products' and individual product brochures for more information.

### GUTTER ACCESSORIES

The Stratco range of gutter accessories includes: gutter brackets, internal and external corners, stop ends to seal the gutter ends, and mitres to continue the guttering around building corners. Stratco offers a unique service that can custom fit mitres and stop ends to your gutters.



### COLOUR PVC DOWNPIPE

Stratco PVC downpipes are co-extruded with an exceptional high gloss exterior grade finish, providing superior, long lasting protection and colour to any outdoor area or building. Available in a choice of Off White, Smooth Cream, Merino, Slate Grey or Gun Metal Grey to match popular patio and housing finishes. Lengths are 3m.



**Sizing Available**

75mm Dia.
90mm Dia.
100 x 50mm*
100 x 75mm**

\*Not Available in QLD  
\*\*Only available in QLD



### SQUARE DOWNPIPES

Stratco Square and Rectangular Downpipes are available in sizes to suit any application from industrial to residential buildings. They are available in galvanised, Zinc/Al and a huge range of roofing colours. Lengths are 1800mm or 2400mm, check your State for availability.

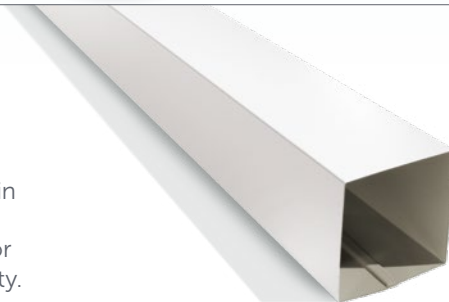

**Sizing Available**

50 x 50mm
75 x 50mm
75 x 75mm
95 x 45mm
100 x 50mm
100 x 75mm
100 x 100mm
125 x 100mm
150 x 100mm
150 x 150mm



Downpipe Size	Roof Area Drained
75 x 50mm	54m <sup>2</sup>
100 x 50mm	71m <sup>2</sup>
100 x 75mm	107m <sup>2</sup>
100 x 100mm	143m <sup>2</sup>
125 x 100mm	179m <sup>2</sup>
150 x 100mm	214m <sup>2</sup>

### ROUND DOWNPIPES

Stratco Round Downpipes are available in a diameter to suit any application from industrial to residential buildings. Lengths of 1800mm and 2400mm are available in galvanised, Zinc/Al or a huge range of roofing colours, check with your State for availability.



**Sizing Available**

50mm Dia.
65mm Dia.
75mm Dia.
90mm Dia.
100mm Dia.
125mm Dia.
150mm Dia.
175mm Dia.



Downpipe Size	Roof Area Drained
50mm Dia.	28m <sup>2</sup>
65mm Dia.	47m <sup>2</sup>
75mm Dia.	63m <sup>2</sup>
90mm Dia.	91m <sup>2</sup>
125mm Dia.	175m <sup>2</sup>
150mm Dia.	252m <sup>2</sup>



# FASCIA & OVERFLOW SOLUTIONS

**RANGE AND AVAILABILITY:** Stratco has a comprehensive range of roofing and rainwater products, and all of the accessories needed to complete your project. A wide range of custom designed products can also be produced to your requirements. Not all products and sizes are available nationally. National product availability is shown by the shaded areas on the map of Australia next to each product. Check with Stratco to confirm availability before ordering any materials.

## CONTINUOUS FASCIA™

Clean, simple, modern details combine with functionality in the attractive Continuous Fascia. Ideal for use on modern and classic homes, this fascia can be ordered to suit your exact requirements.

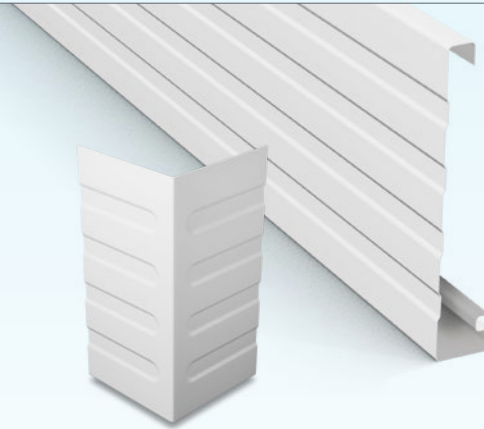

\*Available NT only.

## CONTINUOUS REBATE FASCIA

An attractive fascia that tightly integrates with the gutter system. Benefitting from a functional rebate 'ledge' that houses the gutter system, Stratco Rebate Fascia adds further stability by tightly integrating the fascia and gutter together.

The Rebate Fascia system uses a sturdy end fix bracket which has been specially designed for a quick construction and to eliminate damage to fascia.

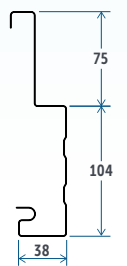

## STEEL GUTTER GUARD

Stratco's heavy duty Zinc/Al gutter guard minimises the collection of leaves and debris in gutters that can lead to blockages and overflow. Designed to suit both tiled or corrugated roofing, the low profile design hides the gutter guard from view and fits in standard 115-125mm wide guttering. Available in a handy 10m pack with easy to install 2m lengths.

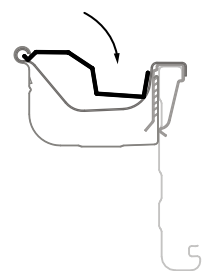
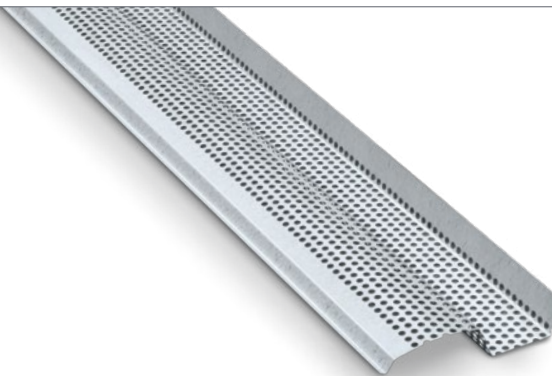

**TECHNICAL INFORMATION:** Torrent Spacer Gutter Clip - Minimum allocated gap tested to stated overflow capacity. Gutter Slots - Minimum slot set-down tested to beyond stated overflow capacity. All testing performed at Stratco Testing Facility, Gepps Cross, South Australia.

## CONTINUOUS OVERFLOW SOLUTIONS

The following overflow solutions provide a measure for continuous overflow for the full length in which the solution is applied. These can be applied in combination with dedicated measures if further overflow capacity is required.

### FRONT GUTTER HEIGHT

Water will overflow to the front of the gutter if the top of the front gutter bead is located below the top of the fascia. Due to the gutter fall, this may occur towards the end of a gutter run in which case the portion of gutter beginning 5mm below the top of the fascia may be used in the overflow calculations.

**OVERFLOW CAPACITY** is determined by the distance (X) that front gutter bead is below top of fascia:  
 $5\text{mm} \leq X < 10\text{mm} = 0.6 \text{ L/s/m}$ ,  $10\text{mm} \leq X < 15\text{mm} = 1.5 \text{ L/s/m}$ ,  $15\text{mm} \leq X < 20\text{mm} = 3.4 \text{ L/s/m}$

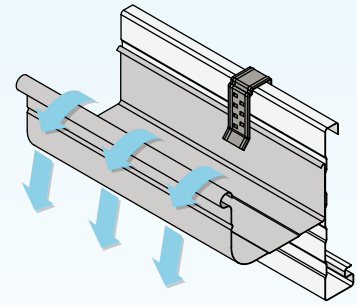

### STRATCO TORRENT SPACER GUTTER CLIP

The perfect solution to create a consistent gap between the gutter and fascia, allowing water to escape through the gap rather than entering the building. The clip facilitates the required 10mm minimum distance between the top of the fascia and the back of the gutter and is available to suit Stratco Continuous and Clickfast steel fascias as well as timber fascia.

**OVERFLOW CAPACITY = 1.5 L/s/m**

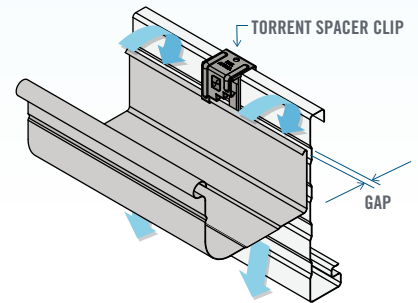

### GUTTER SLOTS

Pre-punched slots are created at 93mm intervals in the front face of the gutter and will release overflow to the front of gutters. The lowest edge of the slots shall be at least 17mm below the top of the fascia which is the minimum distance accommodated by using Stratco Gutter Suspension Clips.

**OVERFLOW CAPACITY = 0.73 L/s/m**

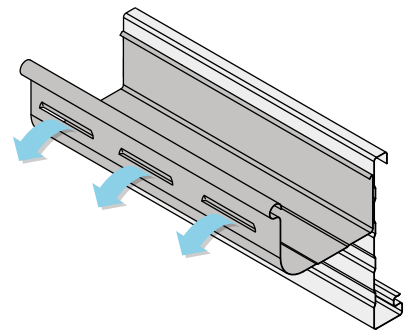

# CUSTOM PRODUCTS

**RANGE AND AVAILABILITY:** Stratco has a comprehensive range of roofing and rainwater products, and all of the accessories needed to complete your project. A wide range of custom designed products can also be produced to your requirements. Not all products and sizes are available nationally. National product availability is shown by the shaded areas on the map of Australia next to each product. Check with Stratco to confirm availability before ordering any materials.







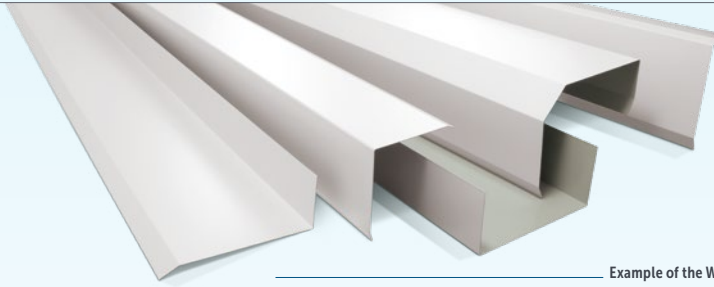





## FLASHINGS

Stratco can fold a wide range of standard, curved or custom flashings to suit your requirements. Stratco flashings allow you to give your job a professional, sturdy and watertight finish.

Flashings are available in pre-painted steel, Zinc/Al, aluminium, stainless steel, and copper. They can be folded in a wide selection of gauges from 0.4mm to 3.0mm depending on your State. Tapered and curved flashings are possible to give your job a professional finish.



Example of the Wide Range of Flashings Available

-  — Box Gutters
-  — Corner Flashings
-  — Sill Flashings
-  — Industrial Gutters
-  — Apron Flashings
-  — Ridge Flashings
-  — Valley Gutters
-  — Footmoulds
-  — Chimney Flashings
-  — Trough Gutters
-  — Pole Plate Flashings
-  — Parapet Flashings

## RAINHEADS

Stratco can manufacture any custom rainhead design to suit your building's architecture. Or choose from one of our three standard styles of rainhead. The simple Flat Bottom Rainhead, the Tapered Bottom Rainhead and the traditional, Colonial Rainhead.

All rainheads include a fitted downpipe outlet and are available in a wide range of sizes. Zinc/Al and a full spectrum of pre-painted roofing colours are available.

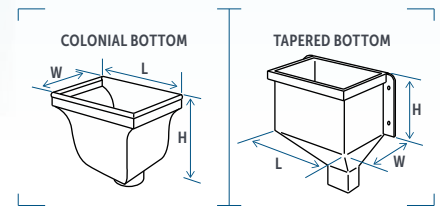

Specify the length, width and height when placing an order.

## SUMPS

Sumps are usually attached between a box gutter and the downpipe. They collect storm-water before being carried away by the downpipe and they also serve to catch any debris before it enters the downpipe.

Sumps can be made to order but are commonly manufactured in either 100mm and 150mm depths. They are available in Zinc/Al and a full spectrum of pre-painted roofing colours to suit your project.



100mm Deep Sump		150mm Deep Sump	
Length	Width	Length	Width
200mm	200mm	350mm	300mm
300mm	200mm	350mm	400mm
300mm	300mm	400mm	400mm
400mm	400mm	400mm	450mm
500mm	500mm	450mm	500mm
600mm	600mm	500mm	500mm
-	-	600mm	600mm

## LOUVRE VENTS

For improved ventilation, add the finishing touch with louvred gable vents from Stratco. Three classic designs of circular, half round and triangular are available in a range of sizes and colours. If a specific depth is required this can be nominated at the time of ordering. Check with your State for availability.

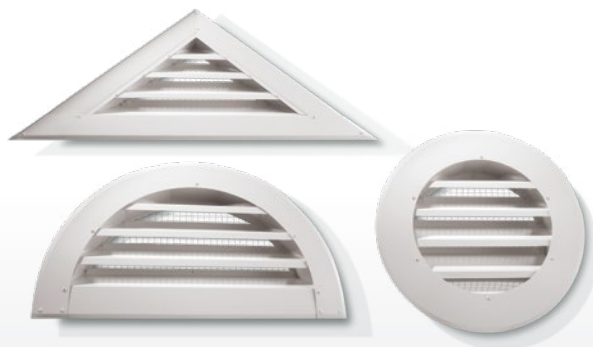

**TECHNICAL INFORMATION:** Refer to the 'Selection, Use and Maintenance of Stratco Products' and individual product brochures for more information.

### EXHALE VENTRIDGE

Specifically designed for metal roofs on housing or on sheds and garages, Exhale® VentrIDGE is an ultra low profile ridge top vent that provides free flowing natural ventilation. Exhale is available in two lengths, either 1220mm long or 2440mm and two pitches, either 22.5° (to suit roof pitch from 20° to 25°) or 12.5° (to suit roof pitch from 10° to 12.5°).

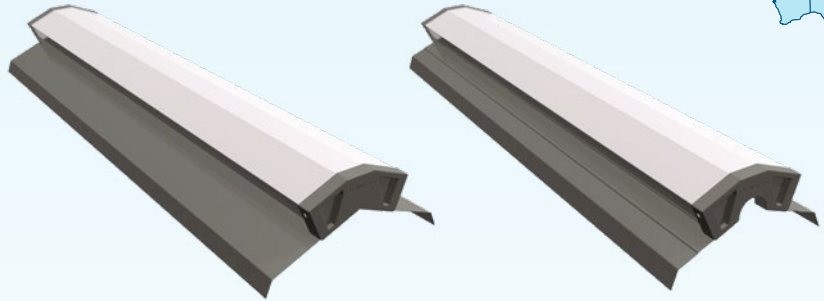

THREE BEND RIDGE

ROLL TYPE RIDGE



### STANDARD VENTRIDGE ASSEMBLED

VentrIDGE provides continuous natural ventilation with effective weather protection under normal weather conditions. It is designed to effectively remove heat, smoke and fumes on an ongoing basis from factories and industrial buildings. It also blends in with a range of building styles due to its low profile.

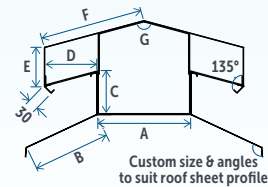
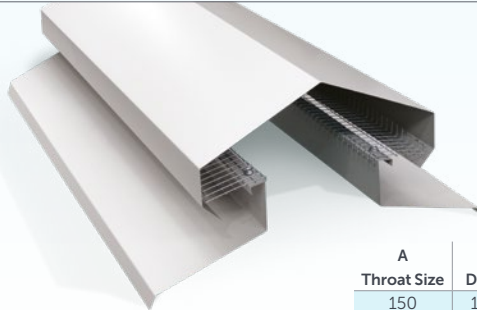

Throat Size	A	B	C	D	E	F	G
150	135	155	65	86	50	175	130°
200	152	172	77	135	85	250	140°
300	250	270	140	169	125	330	150°
400	310	330	212	221	188	436	150°
500	400	420	260	270	213	538	150°
600	380	400	290	358	265	682	150°

### STRATFLO VENTRIDGE UNASSEMBLED

Provides continuous natural ventilation with effective weather protection under normal weather conditions. It takes maximum advantage of natural stack action, which is a result of temperature differences between the inside and outside of the factory. Heat from plant, personnel, and also solar heat radiating through the roof and walls, warm the inside air which rises and flows out of the building through the ventridge.

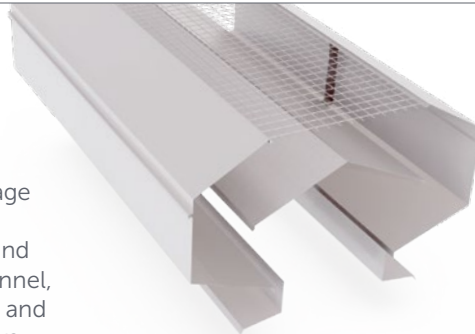

OPTIMUM LENGTH IS 4600mm AND  
MAXIMUM RECOMMENDED LENGTH IS 7600mm.

STANDARD DIMENSIONS

Throat (mm)	Height (mm)	Width (mm)	Mass/Unit Length of Ridge Ventilators (kg/m)
150	230	390	8
225	325	575	12
300	425	760	16
380	520	960	18
450	605	1130	25
600	810	1510	31
750	1010	1885	52
900	1210	2260	62



### WINDOW HOODS

A range of steel window hoods are available in a selection of colours and styles to suit any home. It is an economical solution to keeping your home cooler and shaded from the hot sun. All styles are available in lengths up to 2.4m and up to 1.8m without a lockseam.

Available Styles

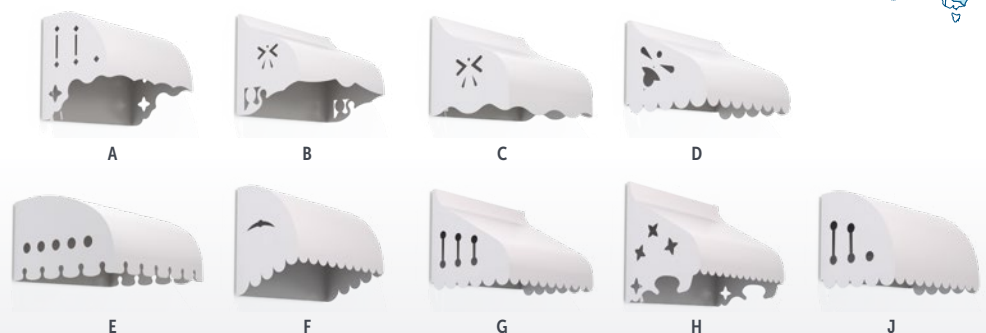



**ROOFING**



« SCAN THIS QR CODE TO FIND A STRATCO NEAR YOU

**1300 155 155**  
**stratco.com.au**

All brands and logos/images accompanied by © or ™ are trade marks of Stratco (Australia) Pty Limited. © Copyright November 2005

**How To.**

