

PATIO LIGHTING[®]

COOLDEK AND BEAM LIGHT

CONTENTS

ALL LIGHTING TYPES

- 240V Power Supply
- Additional Information
- Tools Required
- Connecting Cables

12W LED CEILING LIGHTS

- 12W LED Ceiling Components
- 12W Ceiling Component Layout
- 12W Ceiling Lighting Layout

12W LED COOLDEK LIGHTING INSTALLATION

- Mark And Cut Cooldek Roofing
- Light Recess And Cable Rebate
- Harness And Cable Installation
- Extension Cable Installation
- Install 12W Lights

5W LED CEILING LIGHTS

- 5W LED Ceiling Components
- 5W Ceiling Component Layout
- 5W Ceiling Lighting Layout

5W LED COOLDEK LIGHTING INSTALLATION

- Mark And Cut Cooldek Roofing
- Light Recess And Cable Rebate
- Harness And Cable Installation
- Extension Cable Installation
- Install 5W Lights

OUTBACK BEAM LIGHTS

- Outback Beam Light Components
- Additional Information
- Lighting Layout
- Mark And Drill Outback Beams
- Cable Installation
- Lighting Installation
- Maintenance

ALL LIGHTING TYPES

240V POWER SUPPLY

A licensed electrician must be used to install one 240V general purpose outlet for each lighting kit in accordance with the AS/NZS 3000 Wiring Rules. Position the 240V outlet on wall or column under the verandah, or as close as possible to the intended position of the Patio Lighting Kit power supply/supplies.

The power to the 240V outlet can be switched on and off by connecting to a standard, or dimmable, 240V light switch. The ideal location for this light switch is next to the door leading from the house to the verandah.

Alternatively, a remote controlled general purpose outlet can be purchased from Stratco to turn the lights on and off. The remote controlled outlet is compatible with the Stratco Sunroof and can be programmed as an additional channel on a multi-channel remote control.

Another option is to remove the 240V plug from the power supply cable and wire the power supply cable into the existing 240V outdoor lighting and switches. This must also be performed by a licensed electrician in accordance with the AS/NZS 3000 Wiring Rules.

ADDITIONAL INFORMATION











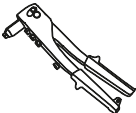
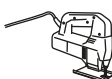

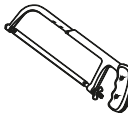

The Patio Lighting Kits includes extra low voltage 30V wiring and LED lights that do not require installation by a licensed electrician, once a 240V outlet has been installed.

Please note that these instructions must be used in conjunction with the Outback "Attached" Flat Verandah, Outback "Flat Attached with Cooldek Roofing" or "Clearspan Gable with Cooldek Roofing" installation guide.

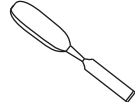
Important Warning:

Each Patio Lighting Kit has a specifically designed power supply. Do not operate the lighting kit with less lights than have been supplied as this will reduce the life of the remaining lights and void the warranty. Do not connect additional lights or different types of lights as this may overload the power supply and will void the warranty.

TOOLS REQUIRED

| | | | | | | | |
|---|---|---|---|---|--|---|---|
|  |  |  |  |  |  |  |  |
| Rivet Gun | Jig Saw | Step Ladder | Tape Measure | Pencil | Hack Saw | Pliers | Power Drill |
|  |  |  |  |  |  |  |  |
| Drill Bit 15 X 500mm 20 X 500mm | Chisel | Adhesive Tape | Stanley Knife | Drafting Compass | Safety Glasses | Vacuum | Gloves |

CONNECTING CABLES

To connect the cables take the male end of the cable and pull back the nut exposing the cable end. (Figure 1.0)

The female end has the thread exposed. (Figure 1.1)

Take care to line up the arrows printed on both cables Push the exposed male end into the female end of the cable you wish to connect.

Once connected screw the nut onto the thread on the female cable ensuring a tight connection. (Figure 1.2)

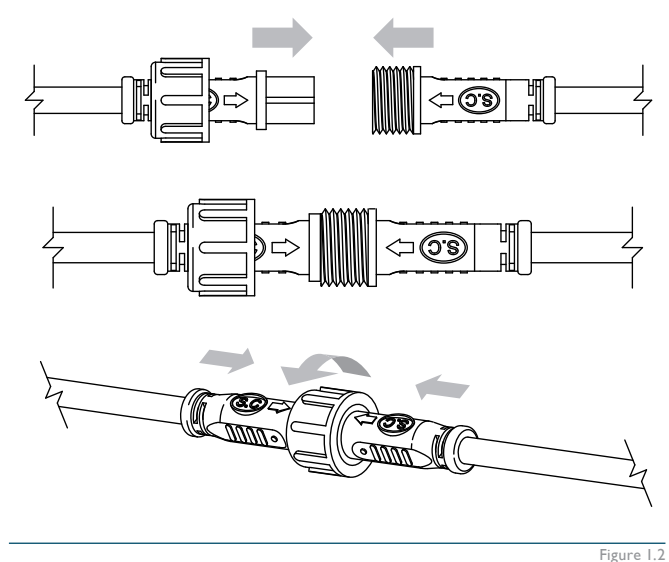
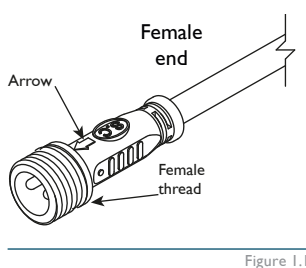
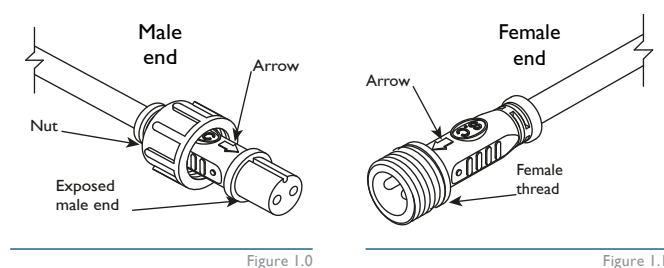

12W LED CEILING LIGHTS

12W LED CEILING COMPONENTS

CABLE HARNESS

Joining the power supply to the extension cables.

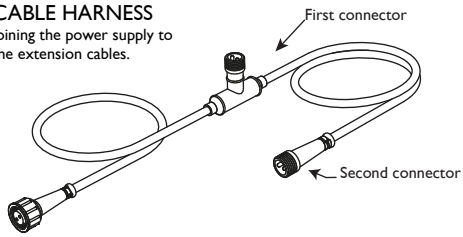

EXTENSION CABLES

Cable joining the light fittings to the cable harness.

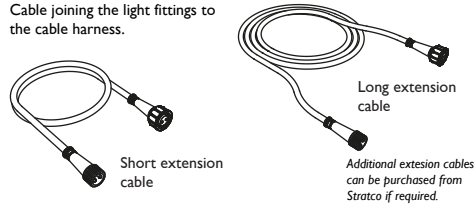

POWER SUPPLY

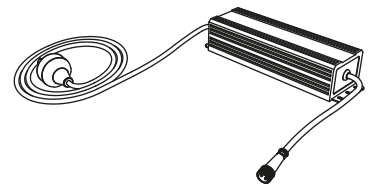

12W LED LIGHT / WHITE

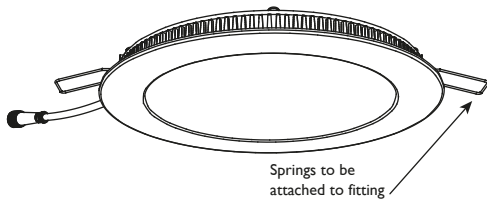

POWER SUPPLY COVER FLASHING & RUBBER GROMMET

Cover flashing to conceal and protect up to two power supplies.

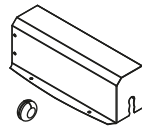

SCREWS AND RIVETS

Fastener types vary depending upon the connection.

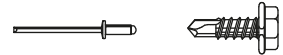

12W CEILING COMPONENT LAYOUT

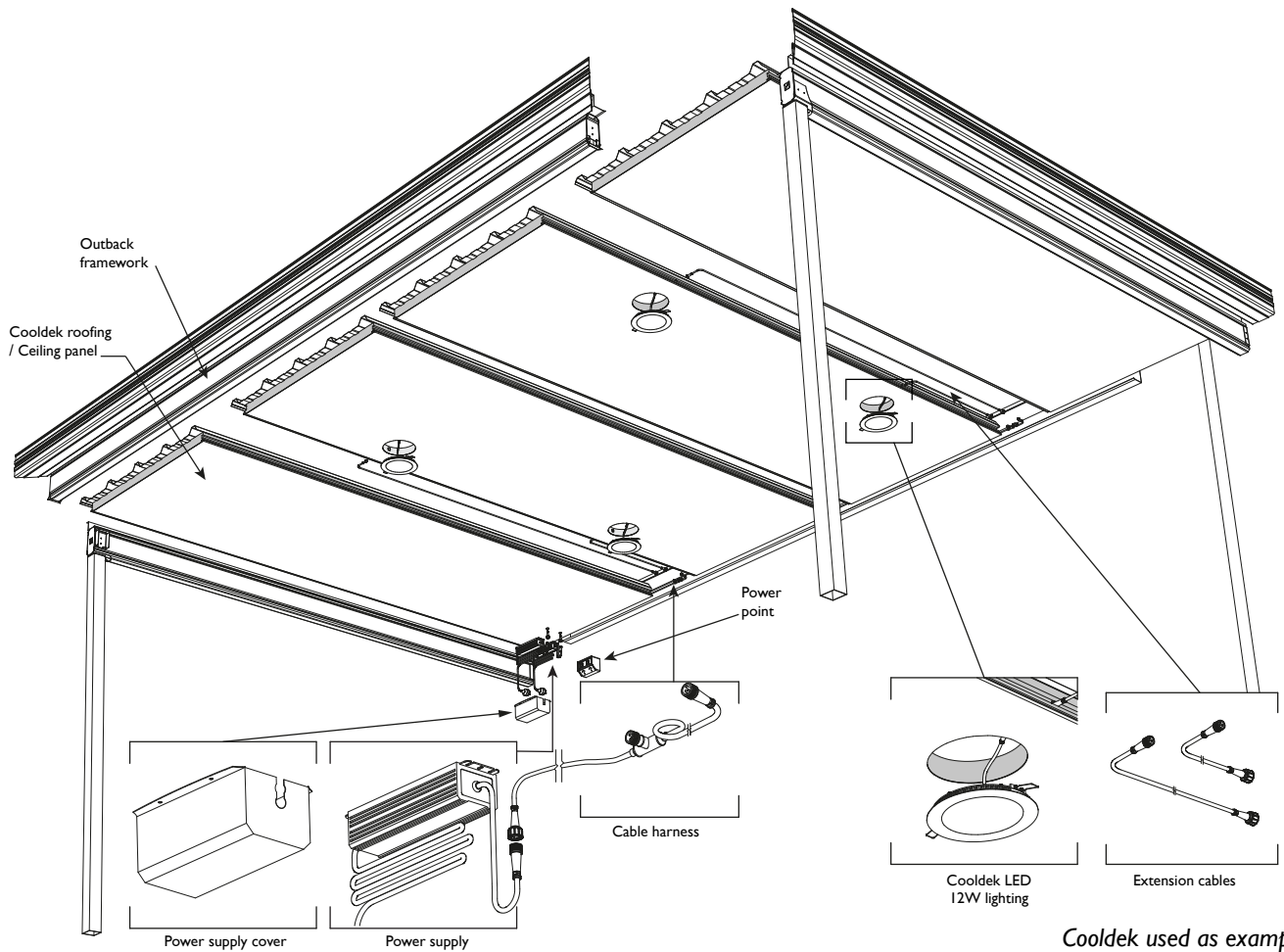

Cooldek used as example

12W CEILING LIGHTING LAYOUT

DESIGN LIGHTING LAYOUT

The lighting layout should be considered and designed prior to installation.

The following points should be factored into the design.

- Lights should be spread every 1.5 to 2.0 meters.
- There are 2 lights per power supply for 12W lights.
- Lights should be set in at least 100mm from the edge of each Cooldek panel.

Figure 2.0 shows five possible lighting designs.

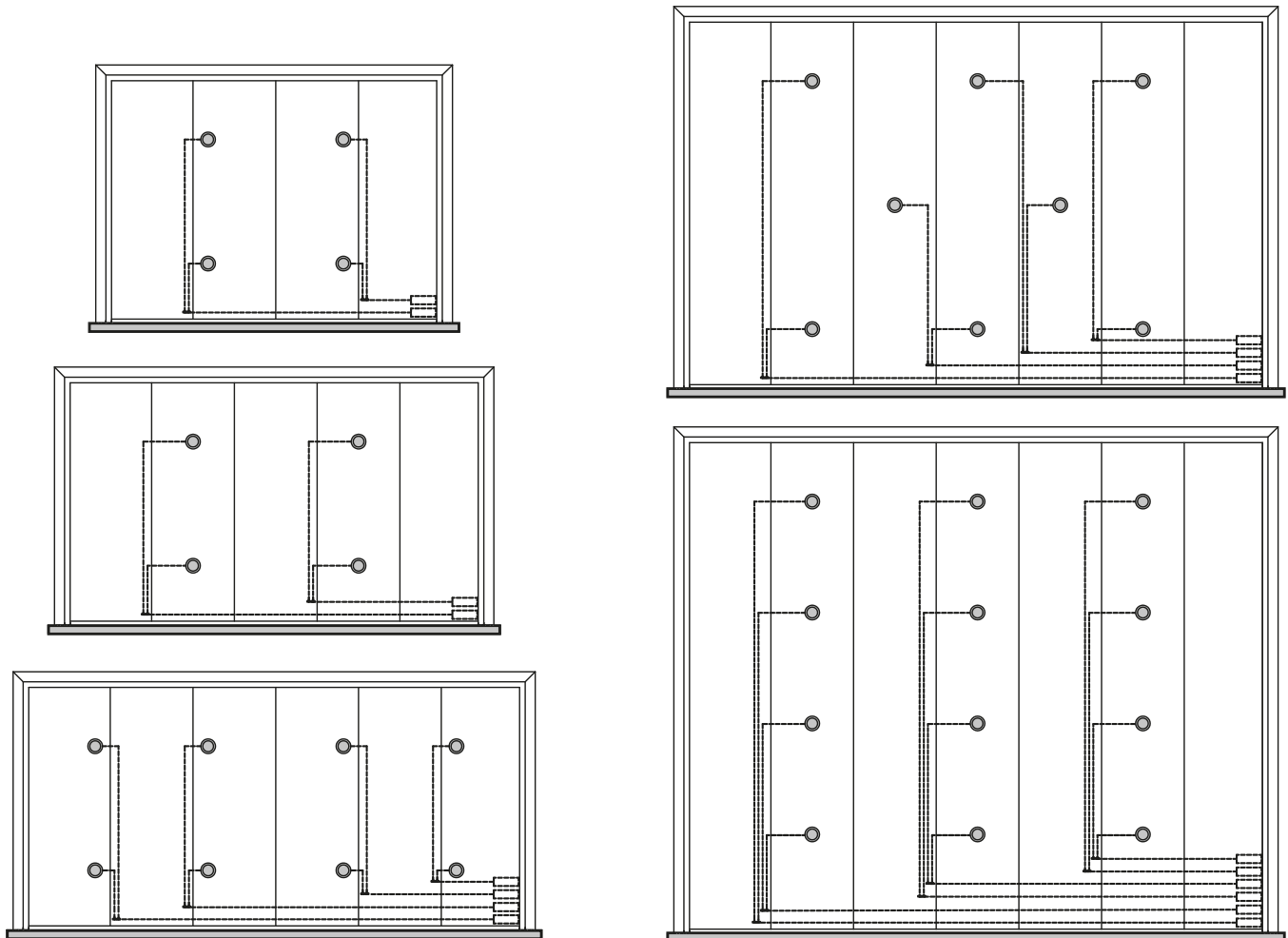
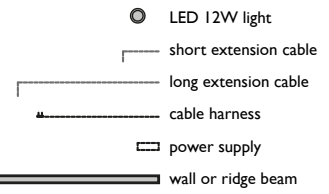

Figure 2.0

12W LED COOLDEK LIGHTING INSTALLATION

MARK AND CUT COOLDEK ROOFING

OUTBACK FRAMEWORK

Install all columns, beams and back channel as per the Cooldek installation instructions.

CUTTING LIGHT HOLES

Before installing Cooldek panels, mark out and cut the recesses for lights. Do not remove the protective plastic coating from the flat surface prior to completing this step.

Mark out the hole locations for $\varnothing 165\text{mm}$ holes in the ceiling panel (on the flat underside) using a compass and drill a starter hole.

Cut the $\varnothing 165\text{mm}$ hole using a jigsaw with a fine tooth metal cutting blade. Be careful to prevent scratches and damage from the jigsaw base plate. It is recommended that an adhesive backed film or padding is taped to the jigsaw base plate to prevent possible damage. (Figure 3.0)

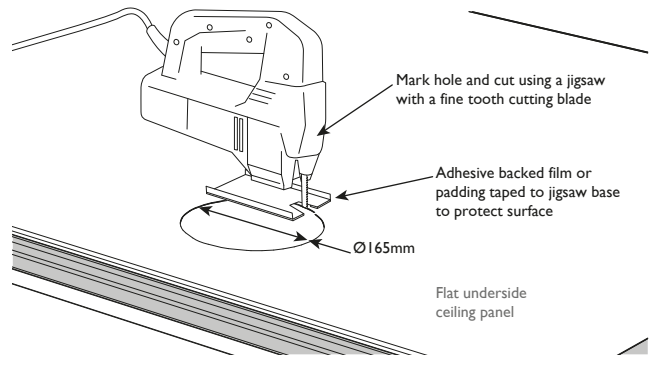

Figure 3.0

LIGHT RECESS AND CABLE REBATE

REMOVE FOAM

Remove the foam insulation with a sharp knife or chisel to form a $\varnothing 165\text{mm}$ x 20mm deep recess for the light fitting. (Figure 3.1)

Ensure there is at least 20mm insulation between the light and roof panel (top skin) to protect the light cables from the sun's heat. (Figure 3.2) This is essential to prevent the light fitting from overheating.

Cut out further foam insulation to make cavities for the springs. The springs are located directly opposite each other (180° apart). (Figure 3.1)

DRILL $\varnothing 15\text{mm}$ HOLE THROUGH FOAM

Drill a $\varnothing 15\text{mm}$ hole from the rebate along the edge of the Cooldek panel to the $\varnothing 165\text{mm}$ light recess. (Figure 3.1 and 3.2) Repeat this step for all light recess locations.

Remove all loose polystyrene foam with a vacuum cleaner.

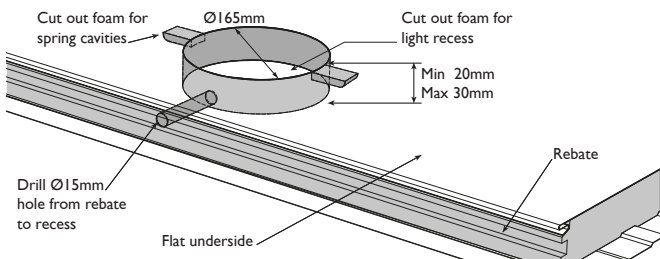

Figure 3.1

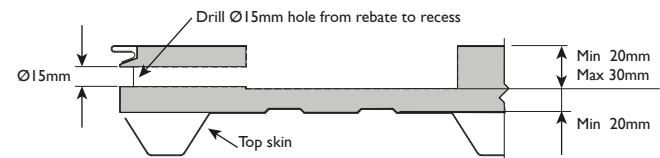

Figure 3.2

DRILL $\varnothing 15\text{mm}$ HOLE THROUGH CEILING

Drill a $\varnothing 15\text{mm}$ hole for the low voltage power cable to pass through the ceiling panel (on the flat underside). The hole must be located adjacent to where the power supply will be. (Figure 3.3)

Note: Do not drill the hole too close to the end of the panel as the panel will be mounted against the fascia or wall, and fixed into the back channel. Allow at least 100mm for the back channel and power supply cover. (Figure 3.3 and 3.4)

CUT CABLE REBATE

Using a sharp knife, cut a rebate for the cable harness along the end of the Cooldek panel. (Figure 3.4)

Ensure the rebate is cut in the end that will be mounted against the fascia or wall, and fixed into the back channel. Repeat this step for all panels carrying the cable harness.

Link the cable rebate to the existing $\varnothing 15\text{mm}$ hole drilled through the ceiling panel. This can be done by drilling another $\varnothing 15\text{mm}$ hole from the rebate into the existing hole. (Figure 3.4)

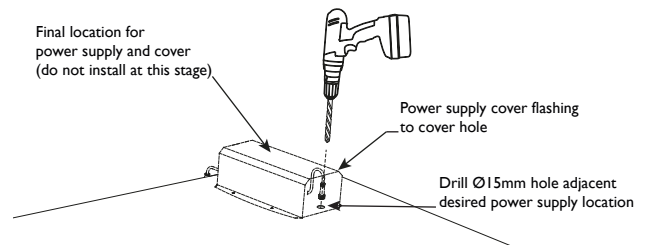

Figure 3.3

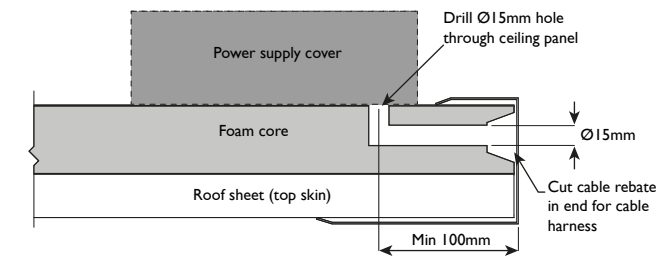

Figure 3.4

HARNESS AND CABLE INSTALLATION

INSTALLING CABLE HARNESS

Feed the end of the cable harness (the power supply end) from the rebate (previously cut in the end of the Cooldek panel) through the Ø15mm hole drilled in the ceiling panel. (Figure 4.0)

Lay the cable harness in the rebate at the end of the Cooldek panel so that the first connector is positioned adjacent to the rebate located along the side of the Cooldek panel. (Figure 4.0)

The cable harness can be held in position with electrical tape if necessary.

SLIDE FIRST COOLDEK PANEL INTO POSITION

Slide the Cooldek panel into the back channel as per the Cooldek instructions.

INSTALLING MORE THAN 1 LIGHT KIT

If installing more than 1 light kit, an additional cable harness will need to be installed and connected to a second power supply. Lay the cable harness in the rebate at the end of the Cooldek panel as outlined in the previous section.

EXTENSION CABLE INSTALLATION

CONNECT EXTENSION CABLES

Connect the extension cable to the connectors on the cable harness. (Figure 4.0) Lay the cable along the edge of the Cooldek panel and feed the end into the closest Ø165mm light recess, ensuring approximately 150mm of cable protrudes. If required, tape the cable into position.

Note: The extension cable should ideally be laid and taped into the cable rebate located along the side of the foam panel containing the light recess. However, in some lighting layouts the extension cable may need to be taped in the rebate of the adjoining panel. (Figure 4.2)

If this occurs, tape the cable and ensure approximately 150mm of cable is left to protrude into the light recess. The cable can be fed into the light recess while installing and sliding the second panel into position.

Excess cable should be looped and laid in the rebate.

In preparation for the installation of the power supply cover cut a slit in the rubber grommet and place it around the cable. (Figure 4.1)

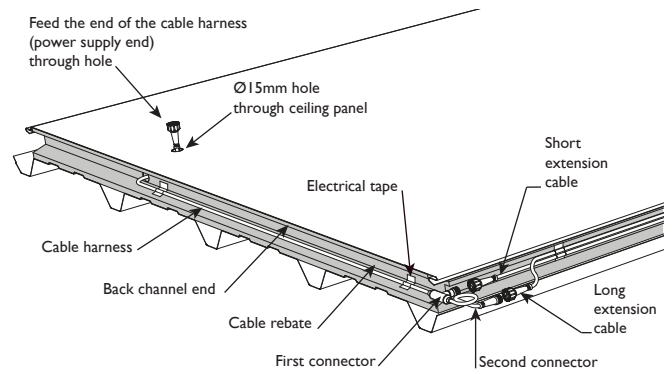

Figure 4.0

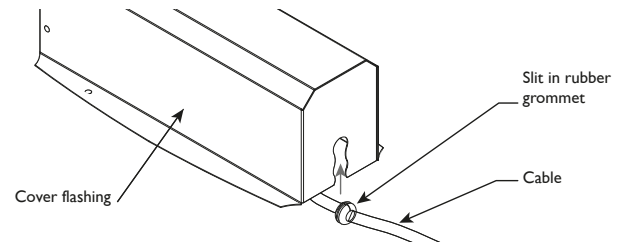

Figure 4.1

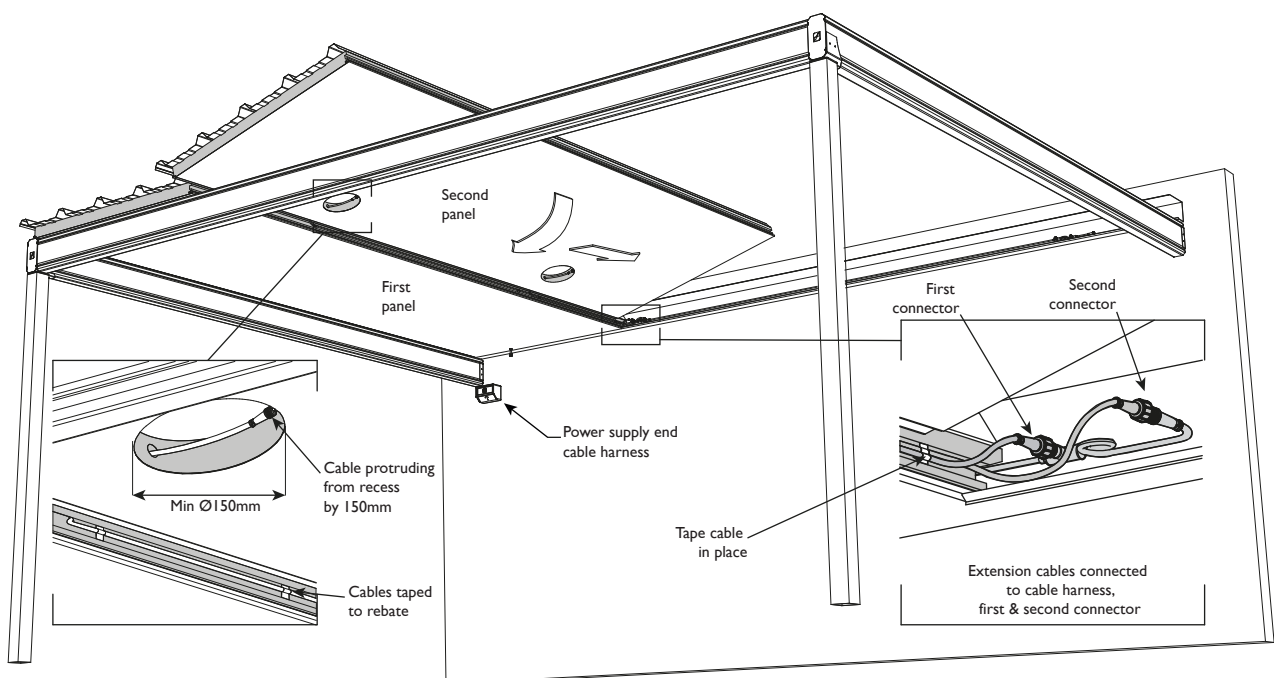

Figure 4.2

INSTALL 12W LIGHTS

FIT SPRINGS

Fit the springs to the light fittings and connect the cables as per the manufacturer's instructions.

COIL EXCESS CABLE

Coil the excess cable above the light fitting and install fittings in the $\varnothing 165\text{mm}$ holes in ceiling panels. (Figure 5.0)

MOUNT POWER SUPPLY

Mount the power supply to the ceiling panel using self drilling screws and connect cable harness to the power supply outlet. An additional power supply will need to be installed for every light kit used.

Plug the power cable into 240V outlet and turn on. Check all lights are illuminated.

FIT COVER

Loop up any excess cables and retain with cable ties. Fit the cover over the power supply and looped cables. (Figure 5.1) Fit the rubber grommet to the slot in the cover, before screwing into position with self drilling screws.

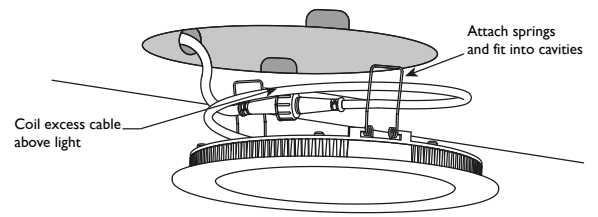

Figure 5.0

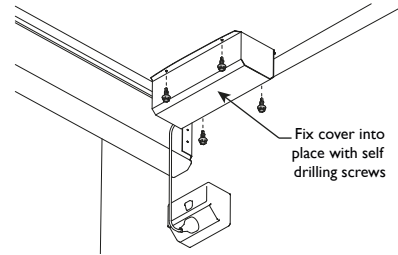

Figure 5.1

5W LED CEILING LIGHTS

5W LED CEILING COMPONENTS

CABLE HARNESS

Cable harness joining the power supply to the extension cable

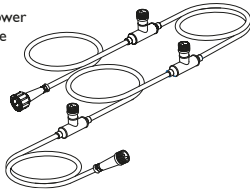

EXTENSION CABLES

Cable joining the light fittings to the cable harness.

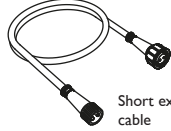

Short extension cable

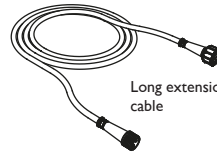

Long extension cable

Additional extension cables can be purchased from Stratco if required.

POWER SUPPLY

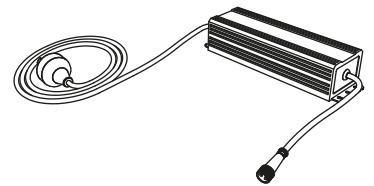

5W LED LIGHT / WHITE or BRUSHED STEEL

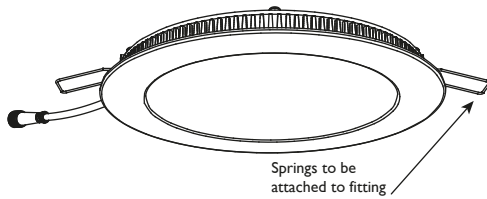

Springs to be attached to fitting

POWER SUPPLY COVER FLASHING & RUBBER GROMMET

Cover flashing to conceal and protect up to two power supplies.

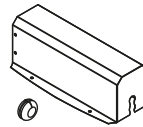

SCREWS AND RIVETS

Fastener types vary depending upon the connection.



5W CEILING COMPONENT LAYOUT

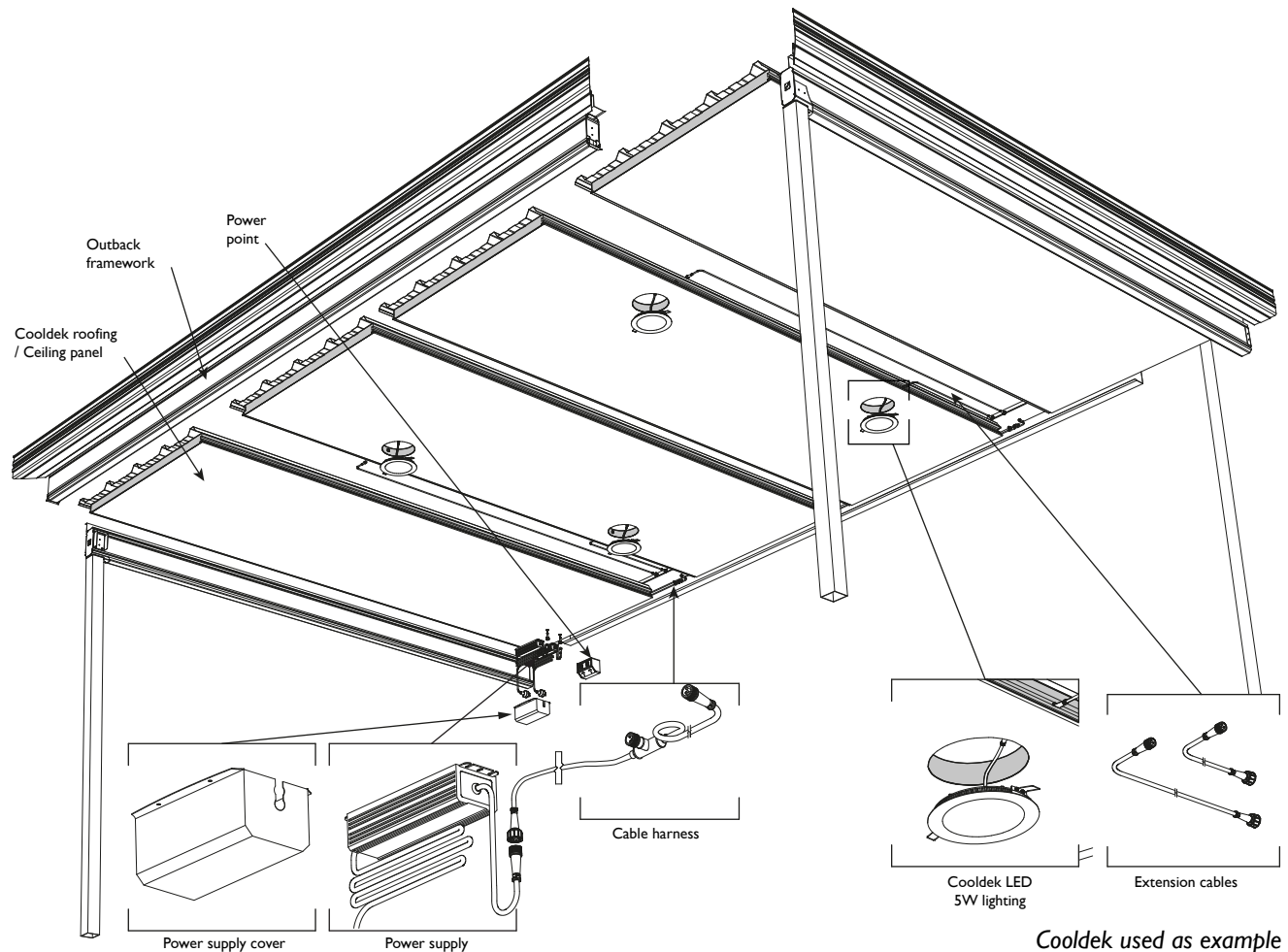

5W CEILING LIGHTING LAYOUT

DESIGN LIGHTING LAYOUT

The lighting layout should be considered and designed prior to installation.

The following points should be factored into the design.

- Lights should be spaced every 1.5 to 2.0 metres.
- There are 4 lights per power supply for 5W /White or Brushed steel lights.
- Lights should be set in at least 100mm from the edge of each Cooldek panel.

Figure 6.0 shows five possible lighting designs.

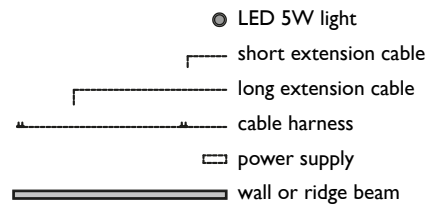

Figure 6.0

5W LED COOLDEK LIGHTING INSTALLATION

MARK AND CUT COOLDEK ROOFING

OUTBACK FRAMEWORK

Install all columns, beams and back channel as per the Cooldek installation instructions.

CUTTING LIGHT HOLES

Before installing Cooldek panels, mark out and cut the recesses for lights. Do not remove the protective plastic coating from the flat surface prior to completing this step.

Mark out the hole locations for $\varnothing 98\text{mm}$ holes in the ceiling panel (on the flat underside) using a compass and drill a starter hole.

Cut the $\varnothing 98\text{mm}$ hole using a jigsaw with a fine tooth metal cutting blade. Be careful to prevent scratches and damage from the jigsaw base plate. It is recommended that an adhesive backed film or padding is taped to the jigsaw base plate to prevent possible damage. (Figure 7.0)

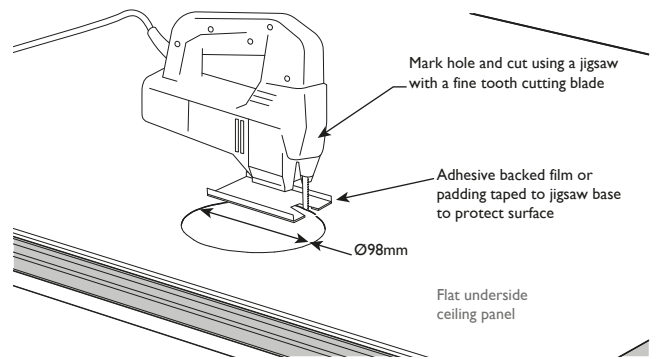

Figure 7.0

LIGHT RECESS AND CABLE REBATE

REMOVE FOAM

Remove the foam insulation with a sharp knife or chisel to form a $\varnothing 98\text{mm} \times 20\text{mm}$ deep recess for the light fitting. (Figure 7.1)

Ensure there is at least 20mm insulation between the light and roof panel (top skin) to protect the light cables from the sun's heat. (Figure 7.2) This is essential to prevent the fitting from overheating.

Cut out further foam insulation to make cavities for the springs. The springs are located directly opposite each other (180° apart). (Figure 7.1)

DRILL $\varnothing 15\text{mm}$ HOLE THROUGH FOAM

Drill a $\varnothing 15\text{mm}$ hole from the rebate along the edge of the Cooldek panel to the $\varnothing 98\text{mm}$ light recess. (Figure 7.1 and 7.2) Repeat this step for all light recess locations.

Remove all loose polystyrene foam with a vacuum cleaner.

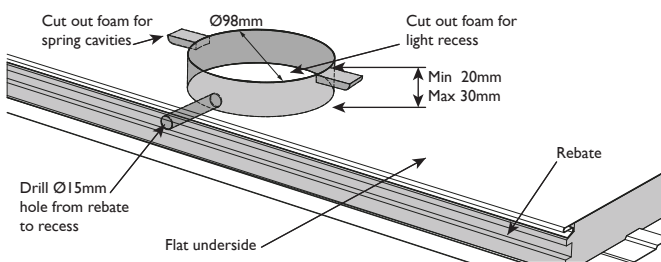

Figure 7.1

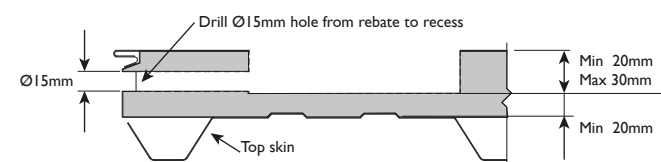

Figure 7.2

DRILL $\varnothing 15\text{mm}$ HOLE THROUGH CEILING

Drill a $\varnothing 15\text{mm}$ hole for the low voltage power cable to pass through the ceiling panel (on the flat underside). The hole must be located adjacent to where the power supply will be. (Figure 7.3)

Note: Do not drill the hole too close to the end of the panel as the panel will be mounted against the fascia or wall, and fixed into the back channel. Allow at least 100mm for the back channel and power supply cover flashing. (Figure 7.3 and 7.4)

CUT CABLE REBATE

Using a sharp knife, cut a rebate for the cable harness along the end of the Cooldek panel. (Figure 7.4) Ensure the rebate is cut in the end that will be mounted against the fascia or wall, and fixed into the back channel. Repeat this step for all panels carrying the cable harness.

Link the cable rebate to the existing $\varnothing 15\text{mm}$ hole drilled through the ceiling panel. This can be done by drilling another $\varnothing 15\text{mm}$ hole from the rebate into the existing hole. (Figure 7.4)

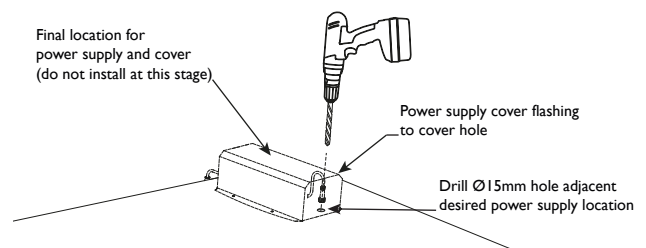

Figure 7.3

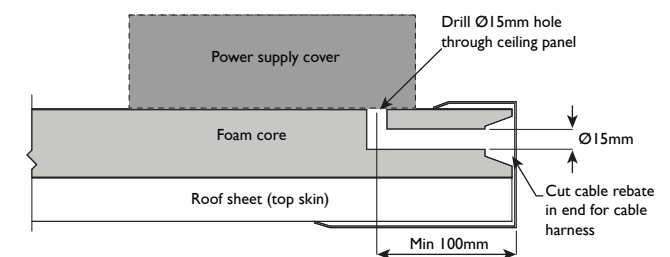

Figure 7.4

HARNESS AND CABLE INSTALLATION

INSTALLING CABLE HARNESS

Feed the end of the cable harness (the power supply end) from the rebate (previously cut in the end of the Cooldek panel) through the Ø15mm hole drilled in the ceiling panel. (Figure 8.0)

Lay the cable harness in the rebate at the end of the Cooldek panel so that the first connector is positioned adjacent to the rebate located along the side of the Cooldek panel. (Figure 8.0)

The cable harness can be held in position with electrical tape if necessary.

SLIDE FIRST COOLDEK PANEL INTO POSITION

Slide the Cooldek panel into the back channel as per the Cooldek instructions.

INSTALLING MORE THAN 2 LIGHTS

If installing more than 2 lights, an additional cable harness will need to be installed and connected to a second power supply. Lay the cable harness in the rebate at the end of the third Cooldek panel as outlined in the previous section.

EXTENSION CABLE INSTALLATION

CONNECT SHORT / LONG EXTENSION CABLE

Connect the short or long extension cable to the first connector on the cable harness. (Figure 8.0) Lay the cable along the edge of the Cooldek panel and feed the end into the closest Ø98mm light recess, ensuring approximately 150mm of cable protrudes into the recess. If required, tape the cable into position.

Note: The extension cable should ideally be laid and taped into the cable rebate located along the side of the foam panel containing the light recess. However, in some lighting layouts, the extension cable may need to be taped in the rebate of the adjoining panel. (Figure 8.2)

If this occurs, tape the cable and ensure approximately 150mm of cable is left to protrude into the light recess. The cable can be fed into the light recess while installing and sliding the second panel into position.

Excess cable should be looped and laid in the rebate.

In preparation for the installation of the power supply cover cut a slit in the rubber grommet and place it around the cable. (Figure 8.1)

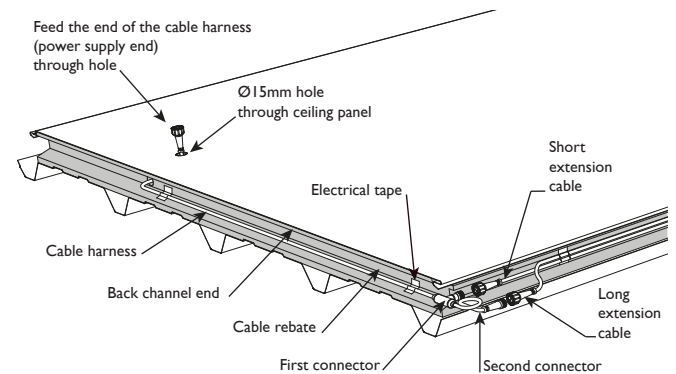

Figure 8.0

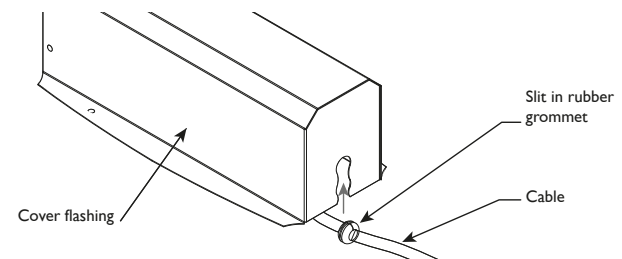

Figure 8.1

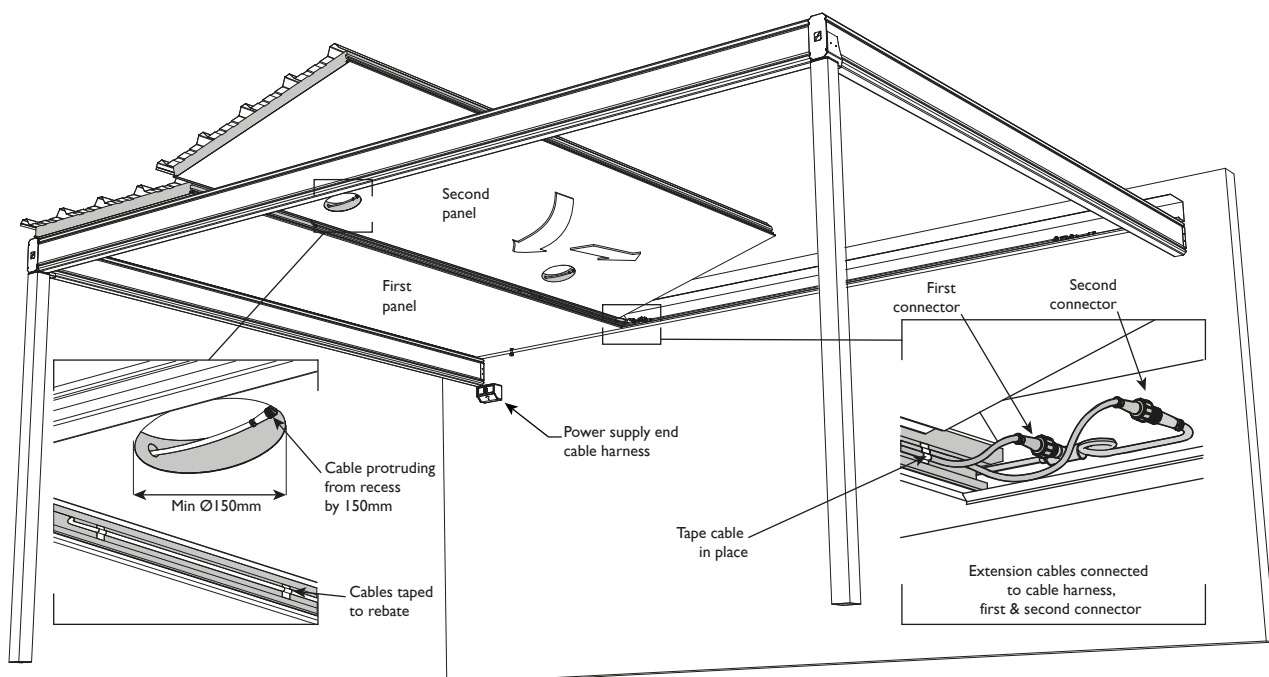

Figure 8.2

INSTALL 5W LIGHTS

FIT SPRINGS

Fit the springs to the light fittings and connect the cables as per manufacturer's instructions.

COIL EXCESS CABLE

Coil the excess cable above light fitting and install fittings in Ø98mm holes in ceiling panels. (Figure 9.0)

MOUNT POWER SUPPLY

Mount the power supply to the ceiling panel using self drilling screws and connect cable harness to the power supply outlet. An additional power supply will need to be installed for every light kit used.

Plug the power cable into 240V outlet and turn on. Check all lights are illuminated.

FIT COVER FLASHING

Loop up any excess cables and retain with cable ties. Fit the cover over the power supply and looped cables. (Figure 9.1) Fit the rubber grommet to the slot in the cover before screwing into position with self drilling screws.

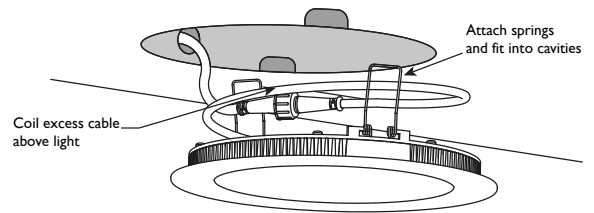

Figure 9.0

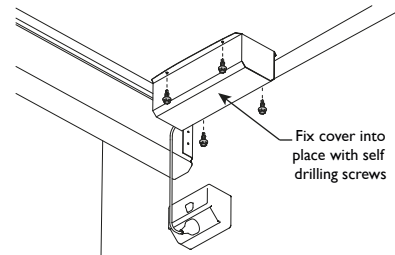
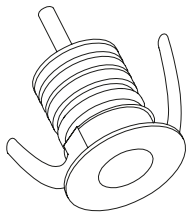

Figure 9.1

OUTBACK BEAM LIGHTS

OUTBACK BEAMLIGHT COMPONENTS

3W LED BEAM LIGHT



SCREWS AND RIVETS

Fastener types vary depending upon the connection.

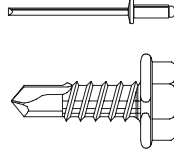

MAIN CABLE

Cable harness joining the power supply to LED lights.

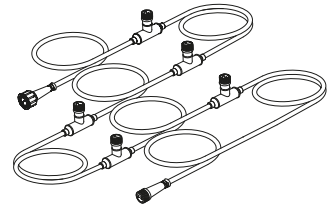

EXTENSION CABLES

Cable joining the light fittings to the cable harness.

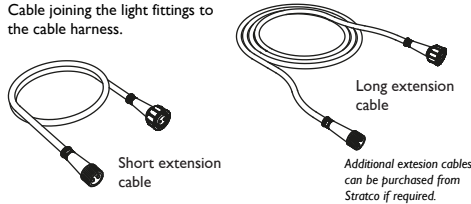

POWER SUPPLY

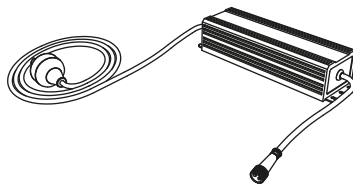

POWER SUPPLY COVER FLASHING & RUBBER GROMMET

Cover flashing to conceal and protect up to two power supplies.

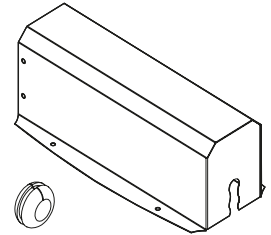

ADDITIONAL INFORMATION

The Patio Beam Lighting Kit includes extra low voltage 30V wiring and LED lights that do not require installation by a licensed electrician, once a 240V outlet has been installed.

Please note that these instructions must be used in conjunction with all Outback product installation guides.

Important Warning:

The power supply is designed specifically for the 6 LED lights in this kit. Do not operate the lights with less than 4 lights connected as this will reduce the life of the remaining lights and void the warranty. Do not connect additional lights or different types of lights as this may overload the power supply and will void the warranty.

LIGHTING LAYOUT

DESIGN LIGHTING LAYOUT

Figure 10.0 shows three possible lighting arrays.

The lighting layout should be considered and designed prior to installation.

The following points should be factored into the lighting array.

- Lights should be spaced every 600mm - 1200mm.
- There are 4-6 lights per power supply.
- Lights should be set in centre of Outback beam.
- Test lights before installing.

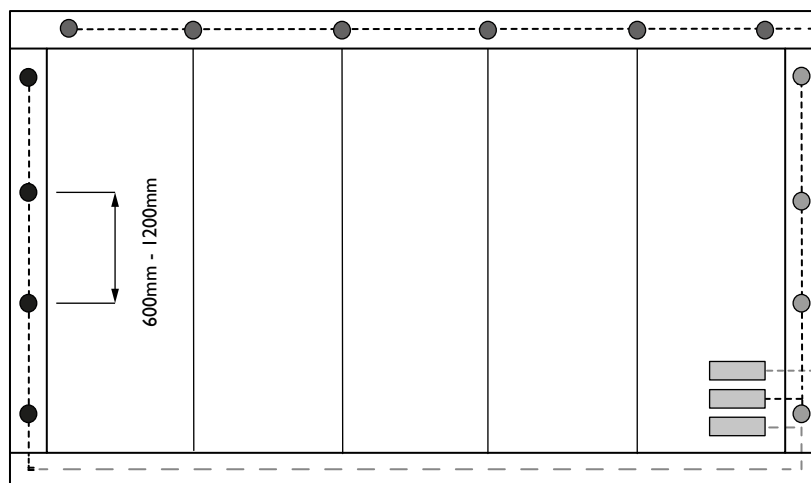

- 4 lights with long extension cable
- 6 lights with short extension cable
- 4 lights on main cable
- ▭ Beam
- ▭ Power supply
- Main Cable
- Short extension cable
- . - . Long extension cable

Figure 10.0

MARK AND DRILL OUTBACK BEAMS

DRILLING LIGHT HOLES

Before installing Outback beams, mark out and drill the Ø29mm holes for the lights on the underside of the beam, to the centre line. (Figure 11.0)

The lights must not be more than 1200mm apart.

Note: Do not remove the protective plastic coating from the beam prior to completing this step.

OUTBACK FRAME WORK

Once appropriate beam are prepared install frame work as per Outback Patio installation guide.

CABLE INSTALLATION

INSTALLING MAIN CABLE

Feed the end of the main cable (the power supply end) through the Ø15mm hole (near the power supply) drilled in the Outback beam. Feed the main cable through the Outback beam so a connector is accessible through each Ø29mm hole.

CONNECT SHORT EXTENSION CABLE IF REQUIRED

Connect the extension cable to the first connector on the main cable. (Figure 11.1) Feed the extension cable along the Outback beam towards the power supply. Feed the extension cable (the power supply end) through the Ø15 hole drilled in the Outback beam and connect to power supply.

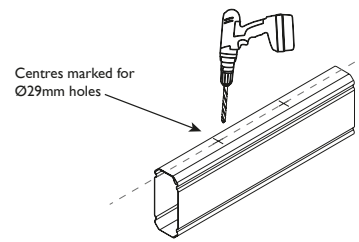

Figure 11.0

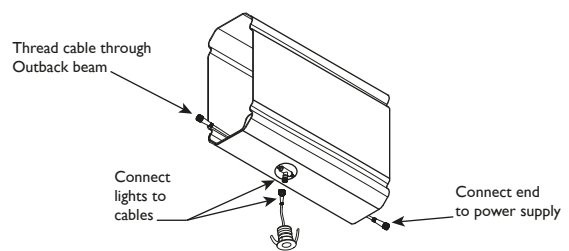

Figure 11.1

LIGHTING INSTALLATION

INSTALLING LIGHTS

Connect the lights to the connectors on the main cable, hold the springs on either side of the light and push through the hole in the beam. While wearing safety gloves twist to lock in place.

MOUNT POWER SUPPLY

Mount the power supply to the ceiling panel using self drilling screws and connect main cable to the power supply outlet. An additional power supply will need to be installed for every set of lights.

Plug the power cable into 240V outlet and turn on. Check all lights are illuminated.

FIT COVER

Loop up any excess cables and retain with cable ties. Fit the cover over the power supply and looped cables. (Figure 11.2) Fit the rubber grommet over the cable and into the slot in the cover before screwing the cover into position with self drilling screws.

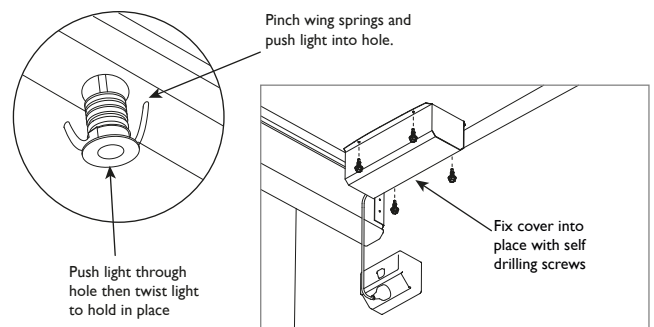

Figure 11.2

MAINTENANCE

Regular maintenance is essential to maintain the good looks of all Stratco steel products and to ensure you receive the maximum life-span possible. Washing with clean water must be frequent enough to prevent the accumulation of dust, salts, and pollutants that may reduce the life of the product. Stratco steel products that are regularly washed by rain require no additional maintenance.

No Stratco steel structure or materials are recommended for use over, or in close proximity, to swimming pools or spas. No material that retains water (such as dirt or paving sand) should be placed against the columns. Care must be taken when determining the location of Stratco steel products so that they are not placed in close contact with sources of pollution or environmental factors that could affect the life of the steel. Refer to the 'Selection, Use and Maintenance' brochure for more information.



« Scan this QR code with your smart phone to find a Stratco near you.

QUEENSLAND • NEW SOUTH WALES • VICTORIA
AUSTRALIAN CAPITAL TERRITORY • SOUTH AUSTRALIA
WESTERN AUSTRALIA • NORTHERN TERRITORY

All brands and logos/images accompanied by ® or ™ are trade marks of Stratco (Australia) Pty Limited.
BROCP1
© Copyright March 2022

Ph: 1300 155 155
stratco.com.au