



INSTALLATION GUIDE

GOOD NEIGHBOUR FENCING

Stratco Good Neighbour fencing is both strong and attractive. Its design allows clean and uncluttered lines to be enjoyed by neighbours on both sides of the fence. Good Neighbour's strength and style is achieved by using fence sheets that fit simply into profiled steel tracks and posts. It is this simple design that makes Good Neighbour fencing so easy to install.

The wide range of colours, fencing profiles and accessories available, mean that a number of different looks can be achieved. Stratco Good Neighbour fence sheet profiles include Superdek, Smartspan, CGI, CGI Mini and Wavelok. Wavelok is specifically designed for fencing applications by Stratco, and features an identical appearance on both sides.

BEFORE YOU START

Ensure you have the correct components and tools before installing your fence. This installation guide should be read in conjunction with the Design Guide. Gates should be installed before the fence is erected, to ensure a neat finish.

TOOLS AND HARDWARE REQUIRED

- Concrete
- Hack-saw
- Plumb Line
- Spirit Level
- Fencing Line
- Tape Measure
- Tin Snips
- Post Hole Digger
- Rivet Gun
- Drill and Hex-head Adaptor



GOOD NEIGHBOUR®

FENCING INSTALLATION GUIDE

GOOD NEIGHBOUR® FENCING

ESTABLISH THE FENCE LINE

Accurately determine where the fence runs. (In some cases a Surveyor may be required) and mark the position using a temporary string line. Using the spacing information from the Design Guide and Table 1.0, mark the post positions of the posts.

TABLE 1.0 - FENCE POST SPACINGS

Sheet Infill Style	3 Sheet	3 Sheet SHS	2 Sheet	2 Sheet SHS
Wavelok, Superdek	2350	2400	1590	1640
CGI, CGI Mini	2390	2440	1630	1680
Smartsan	2170	2220	1470	1520

GATE POST OPENINGS - Single 840mm - Double 3255mm

It may be necessary to use a shorter panel to obtain the required fence run and for better aesthetics this shorter panel should be positioned adjacent to a corner or gate post. Once marked, the post holes can be dug.

The use of a manual or mechanical auger is recommended, especially for harder clay soils. The footing dimensions can be found in the Design Guide. However, the last three holes near a free end and for posts supporting a gate will need to be 100mm deeper than the standard depth specified in the Design Guide.

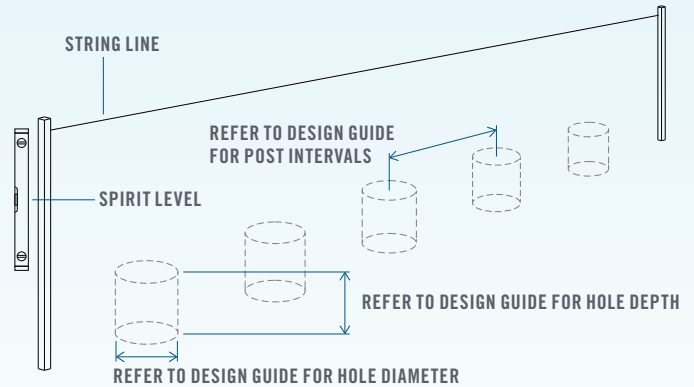

FIGURE 1.0

INSTALLATION OF GATES - All gates should be installed before the remainder of the fence is constructed.

The gate post holes should have already been dug. Fix the hinges to the gate using the screws provided. Two hinges are required per side. Fix the hinges to the SHS gate post, making sure the top of the post is flush with the top of the gate. If the fence extends past the gate, the post for the adjacent panel should be fixed to the SHS gate post.

Once the gate and posts are assembled, place the gate in position. Chock up the centre of the gate with wooden blocks while using a plumb line so that the post is between 8mm and 14mm off vertical. This allows for the deflections under the weight of the gate. With the gate propped the posts can be concreted into place.

PREPARING FOOTINGS

Once the post has been positioned and propped into place, the concrete can be mixed and poured. Prepare the Stratco concrete mix as per the details on the bag and fill the hole with approximately 150mm of concrete. Using a shovel or pole agitate the concrete to remove air pockets. Add a further 150mm and agitate again. This process should be repeated until the hole is full. The top of the footing will need to be smoothed with a trowel ensuring the surface slopes away from the post. No load should be applied to the footing for at least 48 hours. Maximum concrete strength may not occur for up to 28 days, so care should be taken not to apply excessive force to the fence during this time.

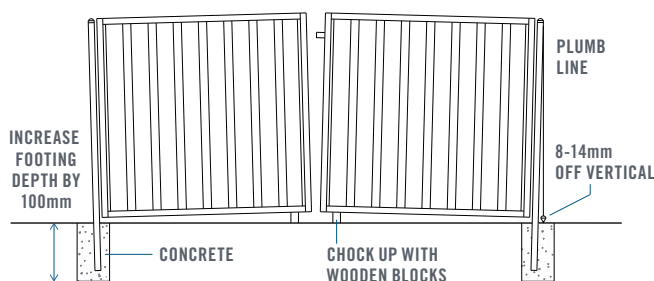

FIGURE 2.0

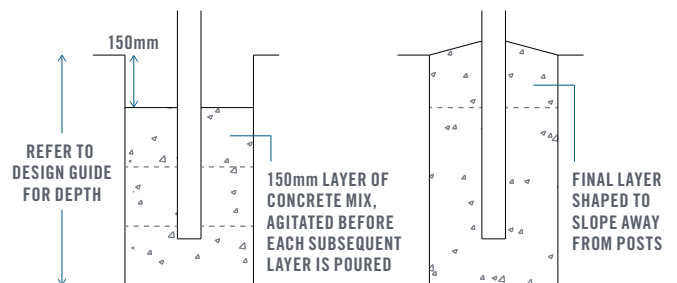
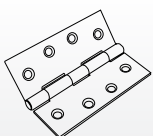
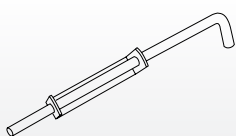

FIGURE 2.1

GATE COMPONENTS AND ACCESSORIES - Components are supplied with fixings.



BUTT HINGE



DROP BOLT

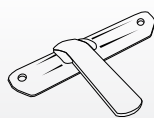

STRIKER PLATE

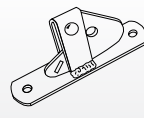

GATE LATCH

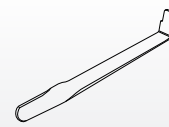

GATE LATCH HANDLE

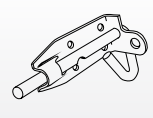

PAD BOLT

FENCE INSTALLATION

Fence panels should be installed starting from a gate post, free end or corner. If you are working on sloped ground and intend to step or slope the fence see the sections on the following page for the correct installation procedure.

ASSEMBLE THE FRAMEWORK

Lay the posts down on the ground and insert the top and bottom track. Fix the tracks using a 10x16mm screw on each side of both ends, see Figure 3.0. The top track should be flush with the top of the post, unless you are installing a screen top, in which case the post will need to extend 300mm past the track. If SHS posts are required, they should be fixed to the fence at this stage using three 10x16mm screws. Caps should be inserted on top of the SHS posts to prevent water entering. When extending from a concreted gate post the frame will need to be assembled vertically in position.

EXTENDING THE FENCE

Assemble the second panel and fix it to the first using three 10x16mm self drilling screws, refer to Figure 3.1. Place the fence into the footing holes. If you are using SHS posts, ensure they are installed between the panels. Prop the fence into the correct position and concrete the joined posts into place. Refer to 'Preparing Footings' for the correct method of concreting the posts. Frames should be assembled and added one at a time, concreting the footings as you install each frame.

When joining around a corner, the posts can be fixed directly to each other or both posts fixed to an SHS column, refer to Figure 3.2. The SHS method must be used if the design calls for the panels to have SHS posts. Post caps and ball caps can be used on a corner post, provided the bottom of the cap is cut to fit on one end, so the cap can sit flush.

INSTALLING THE SHEETS

After the concrete has been allowed to cure for at least 48 hours the fence sheets can be installed. Working on one panel at a time, take off the top track by removing the screws holding it in place. The sheets can now be rotated into the frame. Each sheet should be rotated into position as shown in Figure 3.3, ensuring the correct sheet overlap. (refer to Figure 3.5) The top track can now be reinstalled. Starting at one end and working down to the other, push the track into position, making sure the track is firmly in place. To minimise rattling, the sheets should be fixed together at the overlaps using a 3mm rivet midway up the sheet. In wind speeds W41 and greater, fasten the sheets to the tracks at each of the overlaps using 10x16mm screws.

COMPLETING A CGI MINI PANEL

For CGI mini, two V-shaped flashings are provided. These slide into the tracks with the point of the 'V' to the outside of the panel. A 38x25mm internal rail is installed on one side. The rail is positioned in the gap between the sheet and post, half way down the panel. Angle the rail into position and fix the rail to the post using a 10x16mm screw at each end. The sheets are then fixed to the rail using five 10x20mm ripple self-drilling screws per sheet ensuring it is fastened at each overlap. Sheets should be fixed together at the overlaps using four 3mm rivets midway between the tracks and internal rail, see Figure 3.4.

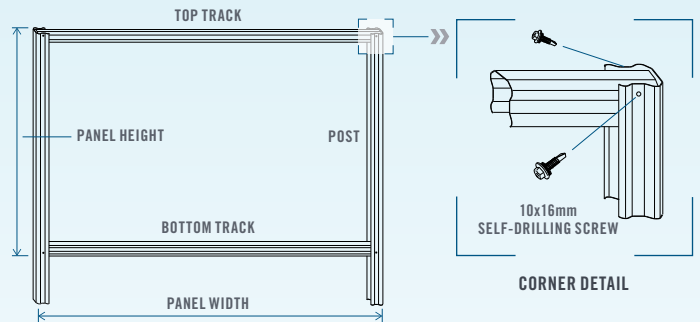

FIGURE 3.0

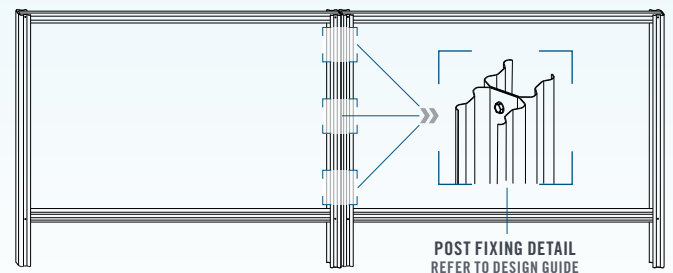

FIGURE 3.1

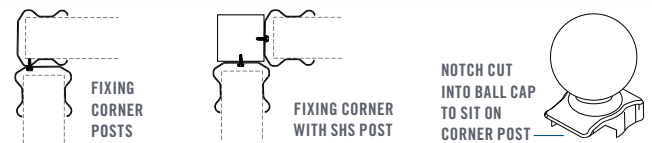

FIGURE 3.2

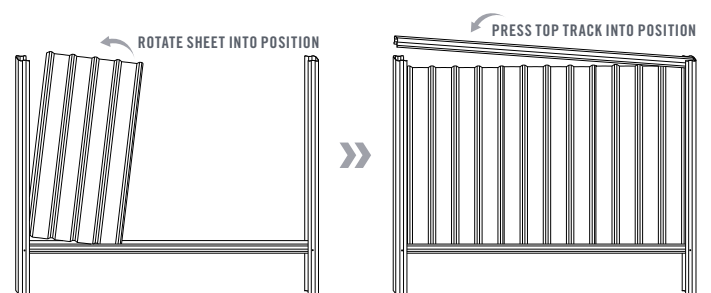

FIGURE 3.3

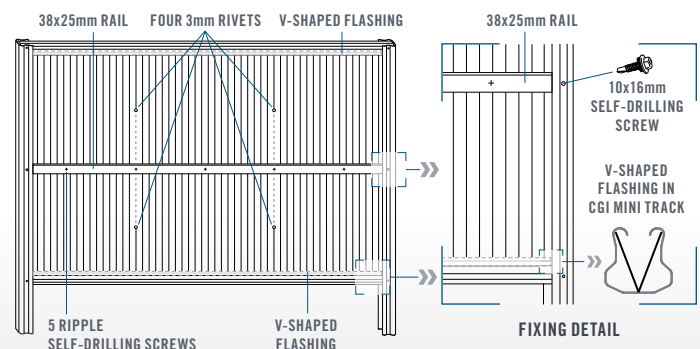
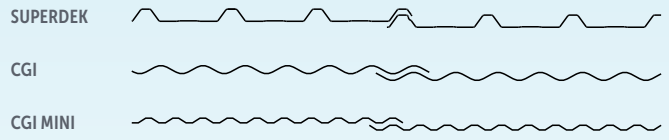
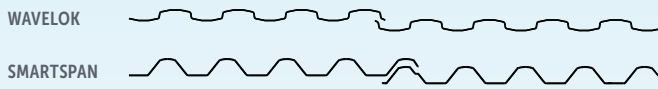

FIGURE 3.4

OVERLAP COVERAGE DETAILS FOR EACH SHEETING PROFILE



The best visual result will be obtained when the sheet overlap is arranged to face away from the most commonly viewed angle.

FIGURE 3.5

SLOPING FENCE

Measure the ground distance between the holes and cut the longer lengths of track to suit. (For slopes less than two degrees, standard tracks and panels will suffice). Assemble the frame as per the previous panel and place the fence into position. Fix the new post to the existing post and concrete the hole. Continue to assemble the next frame.

To install the sheets, both the top and bottom of each sheet will need to be cut to match the angle of the tracks. Use the frame as a guide to mark and cut the lines on the sheets. Allow a total of 10mm clearance to ensure the sheets fit correctly in the tracks. Avoid using an angle grinder to cut the sheets as the swarf and debris may stain the paint. Remove the top track on the panel to install the sheets.

With the sheets in place refit the top track using the same method as with a standard fence. When using a screen-top extension, the lattice will also need to be cut to fit. This should be done after the sheets are installed.

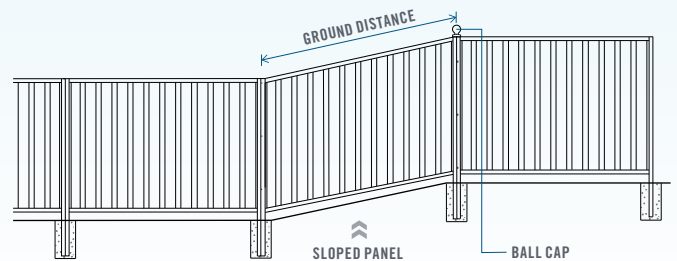

FIGURE 4.0

STEPPED FENCE

A stepped frame should be installed using the same procedure as with a standard fence panel except the post of the higher panel will need to be longer. This will ensure correct post embedment in the footing, refer to Figure 5.0. All tracks and sheets in a stepped fence remain the same size as for a standard panel. If you intend to use post or ball caps both joining posts will need to be the same height in order to sit flush at the top. This is because a post or ball cap is designed to sit over two adjoining posts. A post infill should be used to slide in the open post end, refer to the post infill section on the back page.

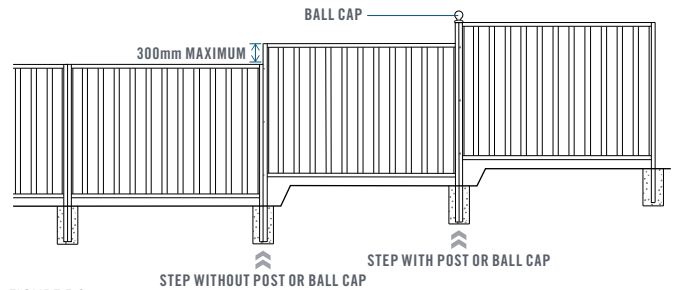

FIGURE 5.0

TAPERED END

Tapering may be required at the free end of a fence. Refer to the 'Design Guide' to check if this is applicable to your situation. The fence will need to be tapered down to at least two thirds of the total fence height. Tapering is to occur over the last two panels. Depending on your fence configuration a longer top track may be required.

The end and middle posts should be cut to the required height. The middle posts need to be cut halfway between the full fence height and the end post height. Position the posts on the ground and install the bottom tracks. Making sure the posts are perpendicular to the bottom tracks, mark and cut the top tracks to fit. A longer track may be required in some configurations. Once cut, the top tracks can be fixed into the frame. Using the method for a standard panel, concrete the posts into place.

The top of each sheet will need to be cut before installing. Use the frame as a template to mark the sheets for cutting. Allow a total of 10mm clearance to ensure the sheets fit correctly in the tracks. Avoid using an angle grinder to cut the sheets as the swarf may stain the paint. Install the cut sheets as with a standard panel installation.

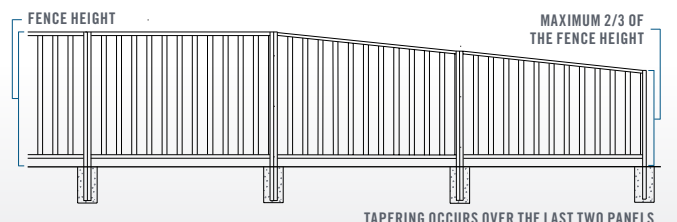

FIGURE 6.0

SCREEN-TOP INSTALLATION

Install the posts, tracks and sheets as detailed in the previous section. Once the posts, tracks and fence sheets are in place, the screen-top components are ready to be installed.

Install the lattice track first. Place the lattice track on top of the existing Good Neighbour track and position it in the middle of the highest point of the track. Fix the lattice track using two self-drilling screws at even spacings.

When the lattice track is in position, the plastic lattice can now be inserted into the lattice track.

The top track must now be installed. First, slide four lattice clips into the top track, spacing them evenly. Push the top track onto the lattice until the lattice fits snugly between the clips. Fix the track to the posts using self-drilling screws, fasten on each side at both ends as per the standard track.

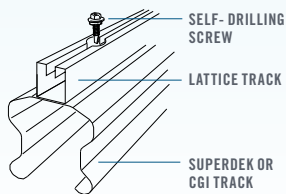

FIGURE 7.0

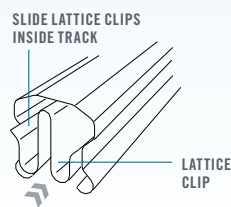

FIGURE 7.1

INSTALLATION ORDER OF SCREEN-TOP COMPONENTS

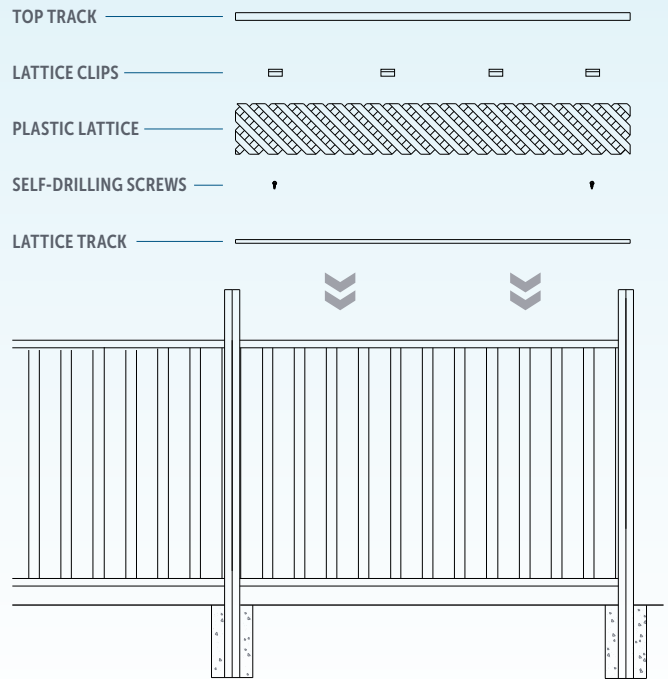

FIGURE 7.2

SCREEN-TOP EXTENSION

This section covers the installation of a new screen top extension to an existing Stratco Good Neighbour fence.

On one corner of the existing fence panel, where the post is fastened to the top track, remove the two 10x16mm screws. Slide the Good Neighbour post extension bracket down, between the outside of the top track and the inside of the post.

Once the post extension bracket is in position, replace the 10x16mm self drilling screws into their existing holes, fastening the post extension bracket to the top track.

Slide the post extension over the post extension bracket. Fasten the post extension to the post extension bracket using one 10x16mm self drilling screw on each side.

Repeat the previous steps for all other post extensions along the fence line. To install the Good Neighbour screen-top componentry, refer to the previous section.

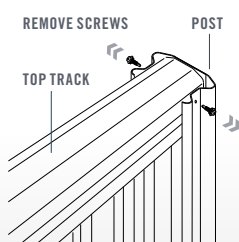

FIGURE 8.0

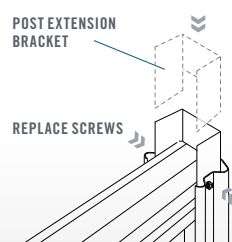

FIGURE 8.1

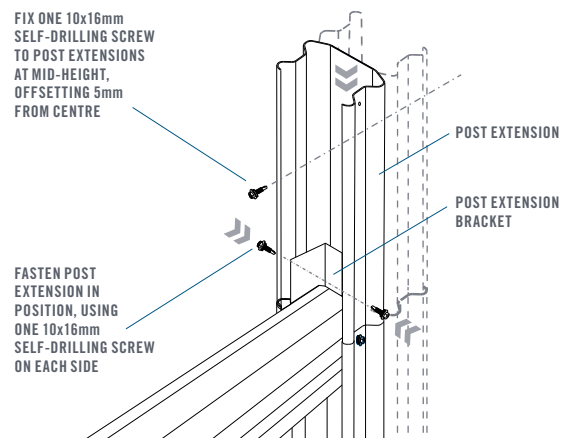

FIGURE 8.2

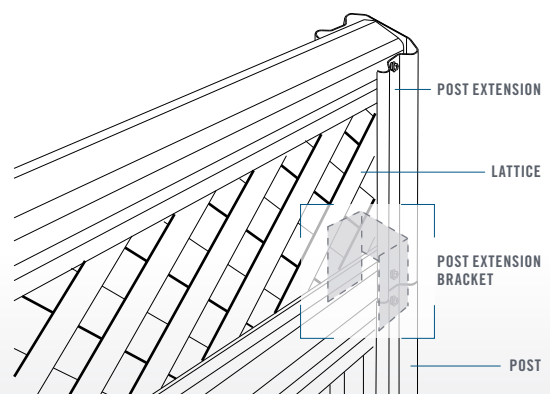

FIGURE 8.3

POST INFILL

Post infills are used to tidy up an exposed post end on stepped panels or end panels where post caps or ball caps are intended to be used. The infill will need to be cut to the required length before being slid into the exposed post. The post or ball cap can now be installed. The cap also prevents the infill from being removed.

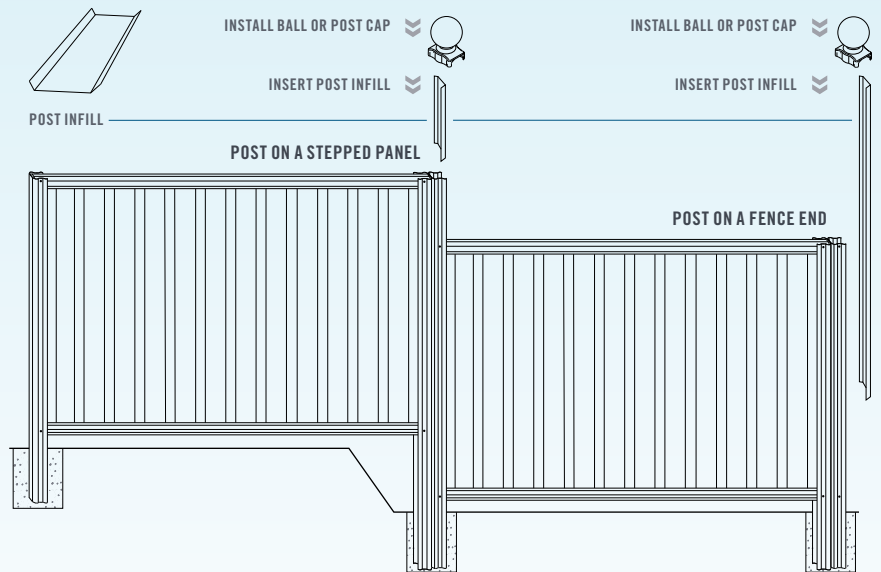

FIGURE 9.0

POST CAP INSTALLATION

Post caps or ball caps are an optional item that can be ordered with a new fence or added to an existing Stratco fence. Caps must be installed upon completion of the fence. Place the chosen cap on top of the two joined posts. Push the cap into position. Drill one hole either side, through both the cap and post, then rivet into position, as shown in Figure 10.0. Plain post caps can be cut in half when used on an end post.

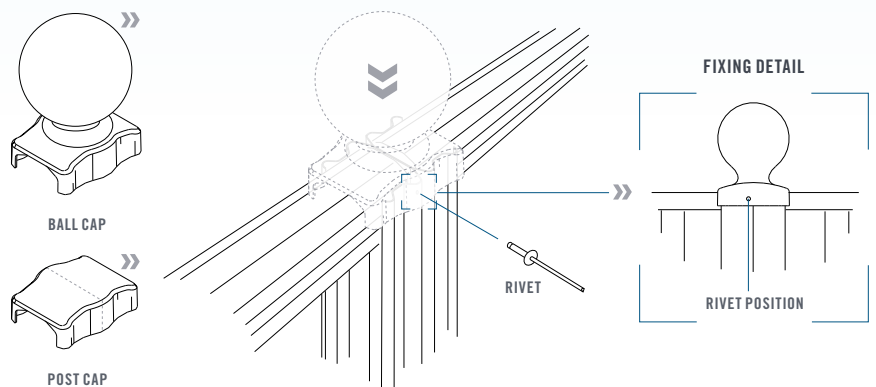
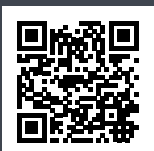

FIGURE 10.0

MAINTENANCE REQUIREMENTS

Fencing should not be located within 1000 metres of a marine environment or in severe industrial or corrosive environments. For more information refer to 'Selection, Use and Maintenance of Stratco Steel Products' Brochure.



« SCAN THIS QR CODE TO FIND A STRATCO NEAR YOU

1300 155 155
stratco.com.au

All brands and logos/images accompanied by ® or ™ are trade marks of Stratco (Australia) Pty Limited. © Copyright April 2004

How To.

